



**MIPS32™ Architecture For Programmers
Volume II: The MIPS32™ Instruction Set**

Document Number: MD00086

Revision 0.95

March 12, 2001

**MIPS Technologies, Inc.
1225 Charleston Road
Mountain View, CA 94043-1353**

Copyright © 2000-2001 MIPS Technologies, Inc. All rights reserved.

Unpublished rights reserved under the Copyright Laws of the United States of America.

This document contains information that is proprietary to MIPS Technologies, Inc. (“MIPS Technologies”). Any copying, modifying or use of this information (in whole or in part) which is not expressly permitted in writing by MIPS Technologies or a contractually-authorized third party is strictly prohibited. At a minimum, this information is protected under unfair competition laws and the expression of the information contained herein is protected under federal copyright laws. Violations thereof may result in criminal penalties and fines.

MIPS Technologies or any contractually-authorized third party reserves the right to change the information contained in this document to improve function, design or otherwise. MIPS Technologies does not assume any liability arising out of the application or use of this information. Any license under patent rights or any other intellectual property rights owned by MIPS Technologies or third parties shall be conveyed by MIPS Technologies or any contractually-authorized third party in a separate license agreement between the parties.

The information contained in this document constitutes one or more of the following: commercial computer software, commercial computer software documentation or other commercial items. If the user of this information, or any related documentation of any kind, including related technical data or manuals, is an agency, department, or other entity of the United States government (“Government”), the use, duplication, reproduction, release, modification, disclosure, or transfer of this information, or any related documentation of any kind, is restricted in accordance with Federal Acquisition Regulation 12.212 for civilian agencies and Defense Federal Acquisition Regulation Supplement 227.7202 for military agencies. The use of this information by the Government is further restricted in accordance with the terms of the license agreement(s) and/or applicable contract terms and conditions covering this information from MIPS Technologies or any contractually-authorized third party.

MIPS, R3000, R4000, R5000, R8000 and R10000 are among the registered trademarks of MIPS Technologies, Inc., and R4300, R20K, MIPS16, MIPS32, MIPS64, MIPS-3D, MIPS I, MIPS II, MIPS III, MIPS IV, MIPS V, MDMX, SmartMIPS, 4K, 4Kc, 4Km, 4Kp, 5K, 5Kc, 20K, 20Kc, EC, MGB, SOC-it, SEAD, YAMON, ATLAS, JALGO, CoreLV and MIPS-based are among the trademarks of MIPS Technologies, Inc.

All other trademarks referred to herein are the property of their respective owners.

Table of Contents

Chapter 1 About This Book	1
1.1 Typographical Conventions	1
1.1.1 Italic Text	1
1.1.2 Bold Text	1
1.1.3 Courier Text	1
1.2 UNPREDICTABLE and UNDEFINED	2
1.2.1 UNPREDICTABLE	2
1.2.2 UNDEFINED	2
1.3 Special Symbols in Pseudocode Notation	2
1.4 For More Information	5
Chapter 2 Guide to the Instruction Set	7
2.1 Understanding the Instruction Fields	7
2.1.1 Instruction Fields	8
2.1.2 Instruction Descriptive Name and Mnemonic	9
2.1.3 Format Field	9
2.1.4 Purpose Field	10
2.1.5 Description Field	10
2.1.6 Restrictions Field	10
2.1.7 Operation Field	11
2.1.8 Exceptions Field	11
2.1.9 Programming Notes and Implementation Notes Fields	11
2.2 Operation Section Notation and Functions	12
2.2.1 Instruction Execution Ordering	12
2.2.2 Pseudocode Functions	12
2.3 Op and Function Subfield Notation	20
2.4 FPU Instructions	20
Chapter 3 The MIPS32™ Instruction Set	21
3.1 Compliance and Subsetting	21
3.2 Alphabetical List of Instructions	21
ABS.fmt	30
ADD	31
ADD.fmt	33
ADDI	34
ADDIU	35
ADDU	36
AND	37
ANDI	38
B	39
BAL	40
BC1F	41
BC1FL	43
BC1T	45
BC1TL	47
BC2F	49
BC2FL	50
BC2T	52
BC2TL	53
BEQ	55
BEQL	56
BGEZ	58
BGEZAL	59
BGEZALL	60
BGEZL	62

BGTZ.....	64
BGTZL.....	65
BLEZ.....	67
BLEZL.....	68
BLTZ.....	70
BLTZAL.....	71
BLTZALL.....	72
BLTZL.....	74
BNE.....	76
BNEL.....	77
BREAK.....	79
C.cond.fmt.....	80
CACHE.....	85
CEIL.W.fmt.....	91
CFC1.....	92
CFC2.....	95
CLO.....	96
CLZ.....	97
COP2.....	99
CTC1.....	100
CTC2.....	103
CVT.D.fmt.....	104
CVT.S.fmt.....	105
CVT.W.fmt.....	106
DERET.....	107
DIV.....	109
DIV.fmt.....	111
DIVU.....	112
ERET.....	113
FLOOR.W.fmt.....	114
J.....	115
JAL.....	116
JALR.....	117
JR.....	119
LB.....	121
LBU.....	122
LDC1.....	123
LDC2.....	124
LH.....	125
LHU.....	126
LL.....	127
LUI.....	129
LW.....	130
LWC1.....	131
LWC2.....	132
LWL.....	133
LWR.....	137
MADD.....	141
MADDU.....	142
MFC0.....	143
MFC1.....	144
MFC2.....	145
MFHI.....	146
MFLO.....	147
MOV.fmt.....	148
MOVF.....	149
MOVF.fmt.....	150
MOVN.....	152
MOVN.fmt.....	153
MOVT.....	155
MOVT.fmt.....	156
MOVZ.....	158
MOVZ.fmt.....	159
MSUB.....	161
MSUBU.....	162
MTC0.....	163

MTC1	164
MTC2	165
MTHI	166
MTLO	167
MUL	169
MUL.fmt	170
MULT	171
MULTU	172
NEG.fmt	173
NOP	174
NOR	175
OR	176
ORI	177
PREF	178
ROUND.W.fmt	183
SB	185
SC	186
SDBBP	189
SDC1	190
SDC2	191
SH	192
SLL	193
SLLV	194
SLT	195
SLTI	196
SLTIU	197
SLTU	198
SQRT.fmt	199
SRA	200
SRAV	201
SRL	202
SRLV	203
SSNOP	204
SUB	205
SUB.fmt	206
SUBU	207
SW	208
SWC1	209
SWC2	210
SWL	211
SWR	213
SYNC	215
SYSCALL	219
TEQ	220
TEQI	221
TGE	222
TGEI	223
TGEIU	224
TGEU	225
TLBP	226
TLBR	227
TLBWI	229
TLBWR	231
TLT	233
TLTI	234
TLTIU	235
TLTU	236
TNE	237
TNEI	238
TRUNC.W.fmt	239
WAIT	241
XOR	243
XORI	244
Appendix A Revision History	245

List of Figures

Figure 2-1: Example of Instruction Description	8
Figure 2-2: Example of Instruction Fields	9
Figure 2-3: Example of Instruction Descriptive Name and Mnemonic	9
Figure 2-4: Example of Instruction Format.....	9
Figure 2-5: Example of Instruction Purpose	10
Figure 2-6: Example of Instruction Description	10
Figure 2-7: Example of Instruction Restrictions	11
Figure 2-8: Example of Instruction Operation	11
Figure 2-9: Example of Instruction Exception	11
Figure 2-10: Example of Instruction Programming Notes	12
Figure 2-11: COP_LW Pseudocode Function.....	13
Figure 2-12: COP_LD Pseudocode Function.....	13
Figure 2-13: COP_SW Pseudocode Function	13
Figure 2-14: COP_SD Pseudocode Function.....	14
Figure 2-15: AddressTranslation Pseudocode Function	14
Figure 2-16: LoadMemory Pseudocode Function.....	15
Figure 2-17: StoreMemory Pseudocode Function	15
Figure 2-18: Prefetch Pseudocode Function	16
Figure 2-19: ValueFPR Pseudocode Function	17
Figure 2-20: StoreFPR Pseudocode Function	18
Figure 2-21: SyncOperation Pseudocode Function.....	18
Figure 2-22: SignalException Pseudocode Function	19
Figure 2-23: NullifyCurrentInstruction PseudoCode Function.....	19
Figure 2-24: CoprocessorOperation Pseudocode Function.....	19
Figure 2-25: JumpDelaySlot Pseudocode Function	19
Figure 2-26: FPConditionCode Pseudocode Function.....	20
Figure 2-27: SetFPConditionCode Pseudocode Function.....	20
Figure 3-1: Usage of Address Fields to Select Index and Way	86
Figure 3-2: Unaligned Word Load Using LWL and LWR	133
Figure 3-3: Bytes Loaded by LWL Instruction	134
Figure 3-4: Unaligned Word Load Using LWL and LWR	138
Figure 3-5: Bytes Loaded by LWL Instruction	139
Figure 3-6: Unaligned Word Store Using SWL and SWR	211
Figure 3-7: Bytes Stored by an SWL Instruction	212
Figure 3-8: Unaligned Word Store Using SWR and SWL	213
Figure 3-9: Bytes Stored by SWR Instruction	214

List of Tables

Table 1-1: Symbols Used in Instruction Operation Statements	3
Table 2-1: AccessLength Specifications for Loads/Stores	16
Table 3-1: CPU Arithmetic Instructions	22
Table 3-2: CPU Branch and Jump Instructions.....	22
Table 3-3: CPU Instruction Control Instructions	23
Table 3-4: CPU Load, Store, and Memory Control Instructions	23
Table 3-5: CPU Logical Instructions	24
Table 3-6: CPU Move Instructions	24
Table 3-7: CPU Shift Instructions	24
Table 3-8: CPU Trap Instructions	25
Table 3-9: Obsolete CPU Branch Instructions.....	25
Table 3-10: FPU Arithmetic Instructions.....	26
Table 3-11: FPU Branch Instructions.....	26
Table 3-12: FPU Compare Instructions	26
Table 3-13: FPU Convert Instructions	26
Table 3-14: FPU Load, Store, and Memory Control Instructions.....	27
Table 3-15: FPU Move Instructions.....	27
Table 3-16: Obsolete FPU Branch Instructions	27
Table 3-17: Coprocessor Branch Instructions.....	27
Table 3-18: Coprocessor Execute Instructions.....	27
Table 3-19: Coprocessor Load and Store Instructions	28
Table 3-20: Coprocessor Move Instructions	28
Table 3-21: Obsolete Coprocessor Branch Instructions.....	28
Table 3-22: Privileged Instructions	28
Table 3-23: EJTAG Instructions	29
Table 3-24: FPU Comparisons Without Special Operand Exceptions	81
Table 3-25: FPU Comparisons With Special Operand Exceptions for QNaNs	82
Table 3-26: Usage of Effective Address	85
Table 3-27: Encoding of Bits[17:16] of CACHE Instruction	86
Table 3-28: Encoding of Bits [20:18] of the CACHE Instruction	87
Table 3-29: Values of the <i>hint</i> Field for the PREF Instruction	179

About This Book

The MIPS32™ Architecture For Programmers Volume II comes as a multi-volume set.

- Volume I describes conventions used throughout the document set, and provides an introduction to the MIPS32™ Architecture
- Volume II provides detailed descriptions of each instruction in the MIPS32™ instruction set
- Volume III describes the MIPS32™ Privileged Resource Architecture which defines and governs the behavior of the privileged resources included in a MIPS32™ processor implementation
- Volume IV-a describes the MIPS16™ Application-Specific Extension to the MIPS32™ Architecture
- Volume IV-b describes the MDMX™ Application-Specific Extension to the MIPS32™ Architecture and is not applicable to the MIPS32™ document set
- Volume IV-c describes the MIPS-3D™ Application-Specific Extension to the MIPS64™ Architecture and is not applicable to the MIPS32™ document set
- Volume IV-d describes the SmartMIPS™ Application-Specific Extension to the MIPS32™ Architecture

1.1 Typographical Conventions

This section describes the use of *italic*, **bold** and `courier` fonts in this book.

1.1.1 Italic Text

- is used for *emphasis*
- is used for *bits*, *fields*, *registers*, that are important from a software perspective (for instance, address bits used by software, and programmable fields and registers), and various *floating point instruction formats*, such as *S*, *D*, and *PS*
- is used for the memory access types, such as *cached* and *uncached*

1.1.2 Bold Text

- represents a term that is being **defined**
- is used for **bits** and **fields** that are important from a hardware perspective (for instance, **register** bits, which are not programmable but accessible only to hardware)
- is used for ranges of numbers; the range is indicated by an ellipsis. For instance, **5..1** indicates numbers 5 through 1
- is used to emphasize **UNPREDICTABLE** and **UNDEFINED** behavior, as defined below.

1.1.3 Courier Text

`Courier` fixed-width font is used for text that is displayed on the screen, and for examples of code and instruction pseudocode.

1.2 UNPREDICTABLE and UNDEFINED

The terms **UNPREDICTABLE** and **UNDEFINED** are used throughout this book to describe the behavior of the processor in certain cases. **UNDEFINED** behavior or operations can occur only as the result of executing instructions in a privileged mode (i.e., in Kernel Mode or Debug Mode, or with the CP0 usable bit set in the Status register). Unprivileged software can never cause **UNDEFINED** behavior or operations. Conversely, both privileged and unprivileged software can cause **UNPREDICTABLE** results or operations.

1.2.1 UNPREDICTABLE

UNPREDICTABLE results may vary from processor implementation to implementation, instruction to instruction, or as a function of time on the same implementation or instruction. Software can never depend on results that are **UNPREDICTABLE**. **UNPREDICTABLE** operations may cause a result to be generated or not. If a result is generated, it is **UNPREDICTABLE**. **UNPREDICTABLE** operations may cause arbitrary exceptions.

UNPREDICTABLE results or operations have several implementation restrictions:

- Implementations of operations generating **UNPREDICTABLE** results must not depend on any data source (memory or internal state) which is inaccessible in the current processor mode
- **UNPREDICTABLE** operations must not read, write, or modify the contents of memory or internal state which is inaccessible in the current processor mode. For example, **UNPREDICTABLE** operations executed in user mode must not access memory or internal state that is only accessible in Kernel Mode or Debug Mode or in another process
- **UNPREDICTABLE** operations must not halt or hang the processor

1.2.2 UNDEFINED

UNDEFINED operations or behavior may vary from processor implementation to implementation, instruction to instruction, or as a function of time on the same implementation or instruction. **UNDEFINED** operations or behavior may vary from nothing to creating an environment in which execution can no longer continue. **UNDEFINED** operations or behavior may cause data loss.

UNDEFINED operations or behavior has one implementation restriction:

- **UNDEFINED** operations or behavior must not cause the processor to hang (that is, enter a state from which there is no exit other than powering down the processor). The assertion of any of the reset signals must restore the processor to an operational state

1.3 Special Symbols in Pseudocode Notation

In this book, algorithmic descriptions of an operation are described as pseudocode in a high-level language notation resembling Pascal. Special symbols used in the pseudocode notation are listed in [Table 1-1](#).

Table 1-1 Symbols Used in Instruction Operation Statements

Symbol	Meaning
\leftarrow	Assignment
$=, \neq$	Tests for equality and inequality
\parallel	Bit string concatenation
x^y	A y -bit string formed by y copies of the single-bit value x
$b\#n$	A constant value n in base b . For instance $10\#100$ represents the decimal value 100, $2\#100$ represents the binary value 100 (decimal 4), and $16\#100$ represents the hexadecimal value 100 (decimal 256). If the "b#" prefix is omitted, the default base is 10.
$x_{y..z}$	Selection of bits y through z of bit string x . Little-endian bit notation (rightmost bit is 0) is used. If y is less than z , this expression is an empty (zero length) bit string.
$+, -$	2's complement or floating point arithmetic: addition, subtraction
$*, \times$	2's complement or floating point multiplication (both used for either)
div	2's complement integer division
mod	2's complement modulo
/	Floating point division
$<$	2's complement less-than comparison
$>$	2's complement greater-than comparison
\leq	2's complement less-than or equal comparison
\geq	2's complement greater-than or equal comparison
nor	Bitwise logical NOR
xor	Bitwise logical XOR
and	Bitwise logical AND
or	Bitwise logical OR
GPRLEN	The length in bits (32 or 64) of the CPU general-purpose registers
$GPR[x]$	CPU general-purpose register x . The content of $GPR[0]$ is always zero.
$FPR[x]$	Floating Point operand register x
$FCC[CC]$	Floating Point condition code CC . $FCC[0]$ has the same value as $COC[1]$.
$FPR[x]$	Floating Point (Coprocessor unit 1), general register x
$CPR[z,x,s]$	Coprocessor unit z , general register x , select s
$CCR[z,x]$	Coprocessor unit z , control register x
$COC[z]$	Coprocessor unit z condition signal
$Xlat[x]$	Translation of the MIPS16 GPR number x into the corresponding 32-bit GPR number
BigEndianMem	Endian mode as configured at chip reset (0 \rightarrow Little-Endian, 1 \rightarrow Big-Endian). Specifies the endianness of the memory interface (see LoadMemory and StoreMemory pseudocode function descriptions), and the endianness of Kernel and Supervisor mode execution.

Table 1-1 Symbols Used in Instruction Operation Statements

Symbol	Meaning
BigEndianCPU	The endianness for load and store instructions (0 → Little-Endian, 1 → Big-Endian). In User mode, this endianness may be switched by setting the <i>RE</i> bit in the <i>Status</i> register. Thus, BigEndianCPU may be computed as (BigEndianMem XOR ReverseEndian).
ReverseEndian	Signal to reverse the endianness of load and store instructions. This feature is available in User mode only, and is implemented by setting the <i>RE</i> bit of the <i>Status</i> register. Thus, ReverseEndian may be computed as (SR _{RE} and User mode).
<i>LLbit</i>	Bit of virtual state used to specify operation for instructions that provide atomic read-modify-write. <i>LLbit</i> is set when a linked load occurs; it is tested and cleared by the conditional store. It is cleared, during other CPU operation, when a store to the location would no longer be atomic. In particular, it is cleared by exception return instructions.
I , I+n , I-n :	<p>This occurs as a prefix to <i>Operation</i> description lines and functions as a label. It indicates the instruction time during which the pseudocode appears to “execute.” Unless otherwise indicated, all effects of the current instruction appear to occur during the instruction time of the current instruction. No label is equivalent to a time label of I. Sometimes effects of an instruction appear to occur either earlier or later — that is, during the instruction time of another instruction. When this happens, the instruction operation is written in sections labeled with the instruction time, relative to the current instruction I, in which the effect of that pseudocode appears to occur. For example, an instruction may have a result that is not available until after the next instruction. Such an instruction has the portion of the instruction operation description that writes the result register in a section labeled I+1.</p> <p>The effect of pseudocode statements for the current instruction labelled I+1 appears to occur “at the same time” as the effect of pseudocode statements labeled I for the following instruction. Within one pseudocode sequence, the effects of the statements take place in order. However, between sequences of statements for different instructions that occur “at the same time,” there is no defined order. Programs must not depend on a particular order of evaluation between such sections.</p>
PC	The <i>Program Counter</i> value. During the instruction time of an instruction, this is the address of the instruction word. The address of the instruction that occurs during the next instruction time is determined by assigning a value to <i>PC</i> during an instruction time. If no value is assigned to <i>PC</i> during an instruction time by any pseudocode statement, it is automatically incremented by either 2 (in the case of a 16-bit MIPS16 instruction) or 4 before the next instruction time. A taken branch assigns the target address to the <i>PC</i> during the instruction time of the instruction in the branch delay slot.
PABITS	The number of physical address bits implemented is represented by the symbol PABITS. As such, if 36 physical address bits were implemented, the size of the physical address space would be $2^{\text{PABITS}} = 2^{36}$ bytes.
FP32RegistersMode	<p>Indicates whether the FPU has 32-bit or 64-bit floating point registers (FPRs). In MIPS32, the FPU has 32 32-bit FPRs in which 64-bit data types are stored in even-odd pairs of FPRs. In MIPS64, the FPU has 32 64-bit FPRs in which 64-bit data types are stored in any FPR.</p> <p>In MIPS32 implementations, FP32RegistersMode is always a 0. MIPS64 implementations have a compatibility mode in which the processor references the FPRs as if it were a MIPS32 implementation. In such a case FP32RegistersMode is computed from the FR bit in the <i>Status</i> register. If this bit is a 0, the processor operates as if it had 32 32-bit FPRs. If this bit is a 1, the processor operates with 32 64-bit FPRs.</p> <p>The value of FP32RegistersMode is computed from the FR bit in the <i>Status</i> register.</p>
InstructionInBranchDelaySlot	Indicates whether the instruction at the Program Counter address was executed in the delay slot of a branch or jump. This condition reflects the <i>dynamic</i> state of the instruction, not the <i>static</i> state. That is, the value is false if a branch or jump occurs to an instruction whose PC immediately follows a branch or jump, but which is not executed in the delay slot of a branch or jump.
SignalException(exception, argument)	Causes an exception to be signaled, using the exception parameter as the type of exception and the argument parameter as an exception-specific argument). Control does not return from this pseudocode function - the exception is signaled at the point of the call.

1.4 For More Information

Various MIPS RISC processor manuals and additional information about MIPS products can be found at the MIPS URL:

<http://www.mips.com>

Comments or questions on the MIPS32™ Architecture or this document should be directed to

Director of MIPS Architecture
MIPS Technologies, Inc.
1225 Charleston Road
Mountain View, CA 94043

or via E-mail to architecture@mips.com.

Guide to the Instruction Set

This chapter provides a detailed guide to understanding the instruction descriptions, which are listed in alphabetical order in the tables at the beginning of the next chapter.

2.1 Understanding the Instruction Fields

[Figure 2-1](#) shows an example instruction. Following the figure are descriptions of the fields listed below:

- “Instruction Fields” on page 8
- “Instruction Descriptive Name and Mnemonic” on page 9
- “Format Field” on page 9
- “Purpose Field” on page 10
- “Description Field” on page 10
- “Restrictions Field” on page 10
- “Operation Field” on page 11
- “Exceptions Field” on page 11
- “Programming Notes and Implementation Notes Fields” on page 11

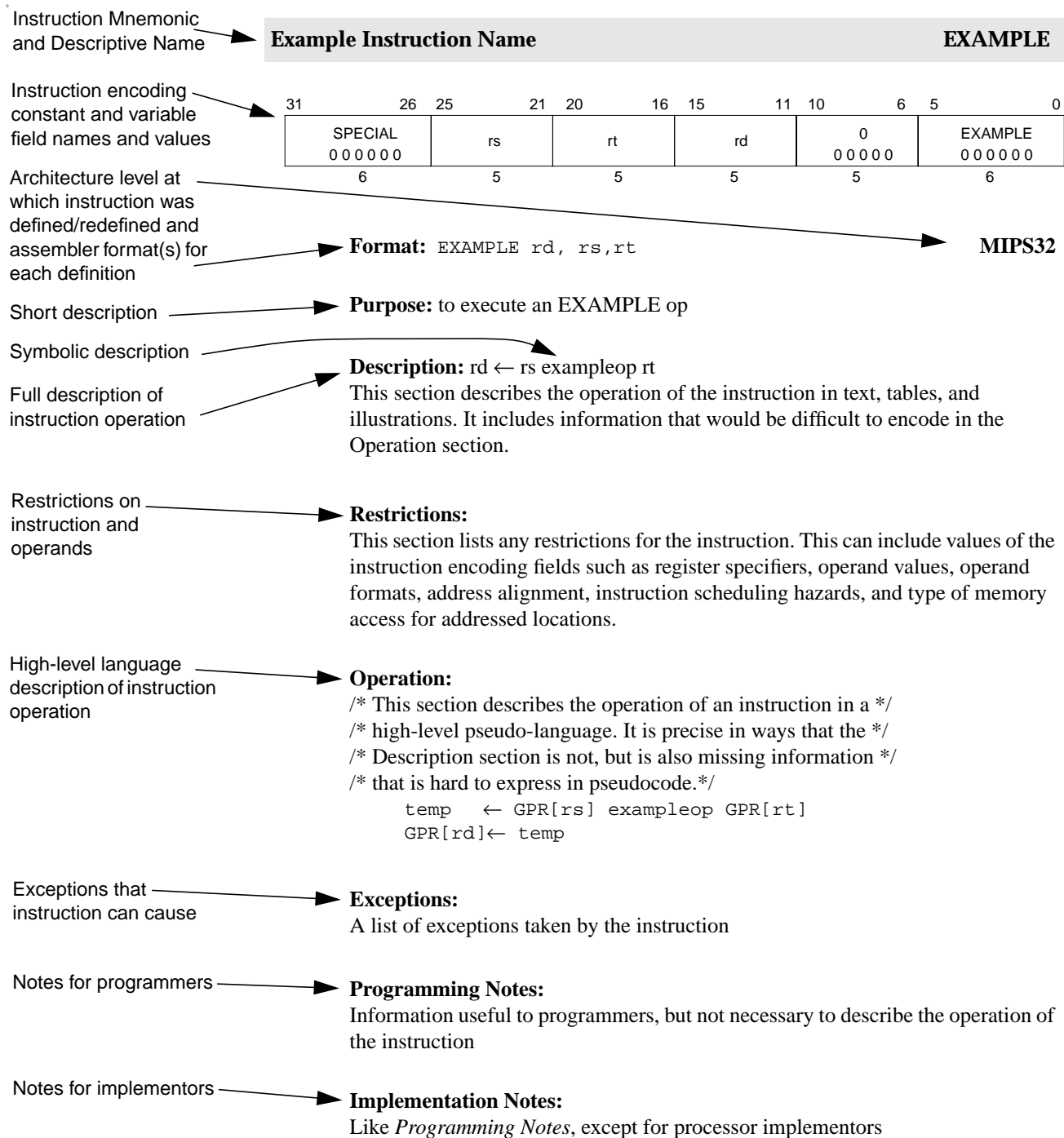

Figure 2-1 Example of Instruction Description

2.1.1 Instruction Fields

Fields encoding the instruction word are shown in register form at the top of the instruction description. The following rules are followed:

- The values of constant fields and the *opcode* names are listed in uppercase (SPECIAL and ADD in Figure 2-2). Constant values in a field are shown in binary below the symbolic or hexadecimal value.
- All variable fields are listed with the lowercase names used in the instruction description (*rs*, *rt* and *rd* in Figure 2-2).
- Fields that contain zeros but are not named are unused fields that are required to be zero (bits 10:6 in Figure 2-2). If such fields are set to non-zero values, the operation of the processor is **UNPREDICTABLE**.

31	26 25	21 20	16 15	11 10	6 5	0
SPECIAL 000000	rs	rt	rd	0 00000	ADD 100000	
6	5	5	5	5	6	

Figure 2-2 Example of Instruction Fields

2.1.2 Instruction Descriptive Name and Mnemonic

The instruction descriptive name and mnemonic are printed as page headings for each instruction, as shown in Figure 2-3.

Add Word	ADD
-----------------	------------

Figure 2-3 Example of Instruction Descriptive Name and Mnemonic

2.1.3 Format Field

The assembler formats for the instruction and the architecture level at which the instruction was originally defined are given in the *Format* field. If the instruction definition was later extended, the architecture levels at which it was extended and the assembler formats for the extended definition are shown in their order of extension (for an example, see C.cond.fmt). The MIPS architecture levels are inclusive; higher architecture levels include all instructions in previous levels. Extensions to instructions are backwards compatible. The original assembler formats are valid for the extended architecture.

Format: ADD rd, rs, rt

MIPS32 (MIPS I)

Figure 2-4 Example of Instruction Format

The assembler format is shown with literal parts of the assembler instruction printed in uppercase characters. The variable parts, the operands, are shown as the lowercase names of the appropriate fields. The architectural level at which the instruction was first defined, for example “MIPS32” is shown at the right side of the page. If the instruction was originally defined in the MIPS I through MIPS V levels of the architecture, that information is enclosed in parentheses.

There can be more than one assembler format for each architecture level. Floating point operations on formatted data show an assembly format with the actual assembler mnemonic for each valid value of the *fmt* field. For example, the ADD.fmt instruction lists both ADD.S and ADD.D.

The assembler format lines sometimes include parenthetical comments to help explain variations in the formats (once again, see C.cond.fmt). These comments are not a part of the assembler format.

2.1.4 Purpose Field

The *Purpose* field gives a short description of the use of the instruction.

Purpose:

To add 32-bit integers. If an overflow occurs, then trap.

Figure 2-5 Example of Instruction Purpose

2.1.5 Description Field

If a one-line symbolic description of the instruction is feasible, it appears immediately to the right of the *Description* heading. The main purpose is to show how fields in the instruction are used in the arithmetic or logical operation.

Description: $rd \leftarrow rs + rt$

The 32-bit word value in GPR *rt* is added to the 32-bit value in GPR *rs* to produce a 32-bit result.

- If the addition results in 32-bit 2's complement arithmetic overflow, the destination register is not modified and an Integer Overflow exception occurs
- If the addition does not overflow, the 32-bit result is placed into GPR *rd*

Figure 2-6 Example of Instruction Description

The body of the section is a description of the operation of the instruction in text, tables, and figures. This description complements the high-level language description in the *Operation* section.

This section uses acronyms for register descriptions. “GPR *rt*” is CPU general-purpose register specified by the instruction field *rt*. “FPR *fs*” is the floating point operand register specified by the instruction field *fs*. “CPI register *fd*” is the coprocessor 1 general register specified by the instruction field *fd*. “FCSR” is the floating point *Control /Status* register.

2.1.6 Restrictions Field

The *Restrictions* field documents any possible restrictions that may affect the instruction. Most restrictions fall into one of the following six categories:

- Valid values for instruction fields (for example, see floating point ADD.fmt)
- ALIGNMENT requirements for memory addresses (for example, see LW)
- Valid values of operands (for example, see DADD)
- Valid operand formats (for example, see floating point ADD.fmt)
- Order of instructions necessary to guarantee correct execution. These ordering constraints avoid pipeline hazards for which some processors do not have hardware interlocks (for example, see MUL).
- Valid memory access types (for example, see LL/SC)

Restrictions:

None

Figure 2-7 Example of Instruction Restrictions**2.1.7 Operation Field**

The *Operation* field describes the operation of the instruction as pseudocode in a high-level language notation resembling Pascal. This formal description complements the *Description* section; it is not complete in itself because many of the restrictions are either difficult to include in the pseudocode or are omitted for legibility.

Operation:

```
temp ← (GPR[rs]31 || GPR[rs]31..0) + (GPR[rt]31 || GPR[rt]31..0)
if temp32 ≠ temp31 then
    SignalException(IntegerOverflow)
else
    GPR[rd] ← temp
endif
```

Figure 2-8 Example of Instruction Operation

See Section 2.2 , "Operation Section Notation and Functions" on page 12 for more information on the formal notation used here.

2.1.8 Exceptions Field

The *Exceptions* field lists the exceptions that can be caused by *Operation* of the instruction. It omits exceptions that can be caused by the instruction fetch, for instance, TLB Refill, and also omits exceptions that can be caused by asynchronous external events such as an Interrupt. Although a Bus Error exception may be caused by the operation of a load or store instruction, this section does not list Bus Error for load and store instructions because the relationship between load and store instructions and external error indications, like Bus Error, are dependent upon the implementation.

Exceptions:

Integer Overflow

Figure 2-9 Example of Instruction Exception

An instruction may cause implementation-dependent exceptions that are not present in the *Exceptions* section.

2.1.9 Programming Notes and Implementation Notes Fields

The *Notes* sections contain material that is useful for programmers and implementors, respectively, but that is not necessary to describe the instruction and does not belong in the description sections.

Programming Notes:

ADDU performs the same arithmetic operation but does not trap on overflow.

Figure 2-10 Example of Instruction Programming Notes

2.2 Operation Section Notation and Functions

In an instruction description, the *Operation* section uses a high-level language notation to describe the operation performed by each instruction. Special symbols used in the pseudocode are described in the previous chapter. Specific pseudocode functions are described below.

This section presents information about the following topics:

- “Instruction Execution Ordering” on page 12
- “Pseudocode Functions” on page 12

2.2.1 Instruction Execution Ordering

Each of the high-level language statements in the *Operations* section are executed sequentially (except as constrained by conditional and loop constructs).

2.2.2 Pseudocode Functions

There are several functions used in the pseudocode descriptions. These are used either to make the pseudocode more readable, to abstract implementation-specific behavior, or both. These functions are defined in this section, and include the following:

- “Coprocessor General Register Access Functions” on page 12
- “Load Memory and Store Memory Functions” on page 14
- “Access Functions for Floating Point Registers” on page 16
- “Miscellaneous Functions” on page 18

2.2.2.1 Coprocessor General Register Access Functions

Defined coprocessors, except for CP0, have instructions to exchange words and doublewords between coprocessor general registers and the rest of the system. What a coprocessor does with a word or doubleword supplied to it and how a coprocessor supplies a word or doubleword is defined by the coprocessor itself. This behavior is abstracted into the functions described in this section.

COP_LW

The *COP_LW* function defines the action taken by coprocessor *z* when supplied with a word from memory during a load word operation. The action is coprocessor-specific. The typical action would be to store the contents of *memword* in coprocessor general register *rt*.

```

COP_LW (z, rt, memword)
  z: The coprocessor unit number
  rt: Coprocessor general register specifier
  memword: A 32-bit word value supplied to the coprocessor

  /* Coprocessor-dependent action */

endfunction COP_LW

```

Figure 2-11 COP_LW Pseudocode Function***COP_LD***

The COP_LD function defines the action taken by coprocessor *z* when supplied with a doubleword from memory during a load doubleword operation. The action is coprocessor-specific. The typical action would be to store the contents of *memdouble* in coprocessor general register *rt*.

```

COP_LD (z, rt, memdouble)
  z: The coprocessor unit number
  rt: Coprocessor general register specifier
  memdouble: 64-bit doubleword value supplied to the coprocessor.

  /* Coprocessor-dependent action */

endfunction COP_LD

```

Figure 2-12 COP_LD Pseudocode Function***COP_SW***

The COP_SW function defines the action taken by coprocessor *z* to supply a word of data during a store word operation. The action is coprocessor-specific. The typical action would be to supply the contents of the low-order word in coprocessor general register *rt*.

```

dataword ← COP_SW (z, rt)
  z: The coprocessor unit number
  rt: Coprocessor general register specifier
  dataword: 32-bit word value

  /* Coprocessor-dependent action */

endfunction COP_SW

```

Figure 2-13 COP_SW Pseudocode Function***COP_SD***

The COP_SD function defines the action taken by coprocessor *z* to supply a doubleword of data during a store doubleword operation. The action is coprocessor-specific. The typical action would be to supply the contents of the low-order doubleword in coprocessor general register *rt*.

```

datadouble ← COP_SD (z, rt)
  z: The coprocessor unit number
  rt: Coprocessor general register specifier
  datadouble: 64-bit doubleword value

  /* Coprocessor-dependent action */

endfunction COP_SD

```

Figure 2-14 COP_SD Pseudocode Function

2.2.2.2 Load Memory and Store Memory Functions

Regardless of byte ordering (big- or little-endian), the address of a halfword, word, or doubleword is the smallest byte address of the bytes that form the object. For big-endian ordering this is the most-significant byte; for a little-endian ordering this is the least-significant byte.

In the *Operation* pseudocode for load and store operations, the following functions summarize the handling of virtual addresses and the access of physical memory. The size of the data item to be loaded or stored is passed in the *AccessLength* field. The valid constant names and values are shown in [Table 2-1](#). The bytes within the addressed unit of memory (word for 32-bit processors or doubleword for 64-bit processors) that are used can be determined directly from the *AccessLength* and the two or three low-order bits of the address.

AddressTranslation

The *AddressTranslation* function translates a virtual address to a physical address and its cache coherence algorithm, describing the mechanism used to resolve the memory reference.

Given the virtual address *vAddr*, and whether the reference is to Instructions or Data (*IorD*), find the corresponding physical address (*pAddr*) and the cache coherence algorithm (*CCA*) used to resolve the reference. If the virtual address is in one of the unmapped address spaces, the physical address and *CCA* are determined directly by the virtual address. If the virtual address is in one of the mapped address spaces then the TLB or fixed mapping MMU determines the physical address and access type; if the required translation is not present in the TLB or the desired access is not permitted, the function fails and an exception is taken.

```

(pAddr, CCA) ← AddressTranslation (vAddr, IorD, LorS)

  /* pAddr: physical address */
  /* CCA: Cache Coherence Algorithm, the method used to access caches*/
  /* and memory and resolve the reference */

  /* vAddr: virtual address */
  /* IorD: Indicates whether access is for INSTRUCTION or DATA */
  /* LorS: Indicates whether access is for LOAD or STORE */

  /* See the address translation description for the appropriate MMU */
  /* type in Volume III of this book for the exact translation mechanism */

endfunction AddressTranslation

```

Figure 2-15 AddressTranslation Pseudocode Function

LoadMemory

The *LoadMemory* function loads a value from memory.

This action uses cache and main memory as specified in both the Cache Coherence Algorithm (*CCA*) and the access (*IorD*) to find the contents of *AccessLength* memory bytes, starting at physical location *pAddr*. The data is returned in a fixed-width naturally aligned memory element (*MemElem*). The low-order 2 (or 3) bits of the address and the *AccessLength* indicate which of the bytes within *MemElem* need to be passed to the processor. If the memory access type of the reference is *uncached*, only the referenced bytes are read from memory and marked as valid within the memory element. If the access type is *cached* but the data is not present in cache, an implementation-specific *size* and *alignment* block of memory is read and loaded into the cache to satisfy a load reference. At a minimum, this block is the entire memory element.

```
MemElem ← LoadMemory (CCA, AccessLength, pAddr, vAddr, IorD)

/* MemElem:  Data is returned in a fixed width with a natural alignment. The */
/*          width is the same size as the CPU general-purpose register, */
/*          32 or 64 bits, aligned on a 32- or 64-bit boundary, */
/*          respectively. */
/* CCA:      Cache Coherence Algorithm, the method used to access caches */
/*          and memory and resolve the reference */

/* AccessLength: Length, in bytes, of access */
/* pAddr:      physical address */
/* vAddr:      virtual address */
/* IorD:      Indicates whether access is for Instructions or Data */

endfunction LoadMemory
```

Figure 2-16 LoadMemory Pseudocode Function

StoreMemory

The *StoreMemory* function stores a value to memory.

The specified data is stored into the physical location *pAddr* using the memory hierarchy (data caches and main memory) as specified by the Cache Coherence Algorithm (*CCA*). The *MemElem* contains the data for an aligned, fixed-width memory element (a word for 32-bit processors, a doubleword for 64-bit processors), though only the bytes that are actually stored to memory need be valid. The low-order two (or three) bits of *pAddr* and the *AccessLength* field indicate which of the bytes within the *MemElem* data should be stored; only these bytes in memory will actually be changed.

```
StoreMemory (CCA, AccessLength, MemElem, pAddr, vAddr)

/* CCA:      Cache Coherence Algorithm, the method used to access */
/*          caches and memory and resolve the reference. */
/* AccessLength: Length, in bytes, of access */
/* MemElem:  Data in the width and alignment of a memory element. */
/*          The width is the same size as the CPU general */
/*          purpose register, either 4 or 8 bytes, */
/*          aligned on a 4- or 8-byte boundary. For a */
/*          partial-memory-element store, only the bytes that will be*/
/*          stored must be valid.*/
/* pAddr:    physical address */
/* vAddr:    virtual address */

endfunction StoreMemory
```

Figure 2-17 StoreMemory Pseudocode Function

Prefetch

The *Prefetch* function prefetches data from memory.

Prefetch is an advisory instruction for which an implementation-specific action is taken. The action taken may increase performance but must not change the meaning of the program or alter architecturally visible state.

```
Prefetch (CCA, pAddr, vAddr, DATA, hint)

/* CCA: Cache Coherence Algorithm, the method used to access */
/* caches and memory and resolve the reference. */
/* pAddr: physical address */
/* vAddr: virtual address */
/* DATA: Indicates that access is for DATA */
/* hint: hint that indicates the possible use of the data */

endfunction Prefetch
```

Figure 2-18 Prefetch Pseudocode Function

Table 2-1 lists the data access lengths and their labels for loads and stores.

Table 2-1 AccessLength Specifications for Loads/Stores

AccessLength Name	Value	Meaning
DOUBLEWORD	7	8 bytes (64 bits)
SEPTIBYTE	6	7 bytes (56 bits)
SEXTIBYTE	5	6 bytes (48 bits)
QUINTIBYTE	4	5 bytes (40 bits)
WORD	3	4 bytes (32 bits)
TRIPLEBYTE	2	3 bytes (24 bits)
HALFWORD	1	2 bytes (16 bits)
BYTE	0	1 byte (8 bits)

2.2.2.3 Access Functions for Floating Point Registers

The pseudocode shown in below specifies how the unformatted contents loaded or moved to CP1 registers are interpreted to form a formatted value. If an FPR contains a value in some format, rather than unformatted contents from a load (uninterpreted), it is valid to interpret the value in that format (but not to interpret it in a different format).

ValueFPR

The ValueFPR function returns a formatted value from the floating point registers.

```

value ← ValueFPR(fpr, fmt)

/* value: The formatted value from the FPR */

/* fpr:   The FPR number */
/* fmt:   The format of the data, one of: */
/*        S, D, W, */
/*        OB, QH, */
/*        UNINTERPRETED_WORD, */
/*        UNINTERPRETED_DOUBLEWORD */
/* The UNINTERPRETED values are used to indicate that the datatype */
/* is not known as, for example, in SWC1 and SDC1 */

case fmt of
  S, W, UNINTERPRETED_WORD:
    valueFPR ← FPR[fpr]

  D, UNINTERPRETED_DOUBLEWORD:
    if (fpr0 ≠ 0) then
      valueFPR ← UNPREDICTABLE
    else
      valueFPR ← FPR[fpr+1] || FPR[fpr]
    endif

  DEFAULT:
    valueFPR ← UNPREDICTABLE

endcase
endfunction ValueFPR

```

Figure 2-19 ValueFPR Pseudocode Function

StoreFPR

The pseudocode shown below specifies the way a binary encoding representing a formatted value is stored into CP1 registers by a computational or move operation. This binary representation is visible to store or move-from instructions. Once an FPR receives a value from the StoreFPR(), it is not valid to interpret the value with ValueFPR() in a different format.

```

StoreFPR (fpr, fmt, value)

/* fpr:   The FPR number */
/* fmt:   The format of the data, one of: */
/*        S, D, W, */
/*        OB, QH, */
/*        UNINTERPRETED_WORD, */
/*        UNINTERPRETED_DOUBLEWORD */
/* value: The formatted value to be stored into the FPR */

/* The UNINTERPRETED values are used to indicate that the datatype */
/* is not known as, for example, in LWC1 and LDC1 */

case fmt of
  S, W, UNINTERPRETED_WORD:
    FPR[fpr] ← value

  D, UNINTERPRETED_DOUBLEWORD:
    if (fpr0 ≠ 0) then
      UNPREDICTABLE
    else
      FPR[fpr] ← value
      FPR[fpr+1] ← value
    endif

endcase

endfunction StoreFPR

```

Figure 2-20 StoreFPR Pseudocode Function

2.2.2.4 Miscellaneous Functions

This section lists miscellaneous functions not covered in previous sections.

SyncOperation

The SyncOperation function orders loads and stores to synchronize shared memory.

This action makes the effects of the synchronizable loads and stores indicated by *stype* occur in the same order for all processors.

```

SyncOperation(stype)

/* stype: Type of load/store ordering to perform. */

/* Perform implementation-dependent operation to complete the */
/* required synchronization operation */

endfunction SyncOperation

```

Figure 2-21 SyncOperation Pseudocode Function

SignalException

The SignalException function signals an exception condition.

This action results in an exception that aborts the instruction. The instruction operation pseudocode never sees a return from this function call.

```
SignalException(Exception, argument)

/* Exception:   The exception condition that exists. */
/* argument:   A exception-dependent argument, if any */

endfunction SignalException
```

Figure 2-22 SignalException Pseudocode Function

NullifyCurrentInstruction

The NullifyCurrentInstruction function nullifies the current instruction.

The instruction is aborted. For branch-likely instructions, nullification kills the instruction in the delay slot during its execution.

```
NullifyCurrentInstruction()

endfunction NullifyCurrentInstruction
```

Figure 2-23 NullifyCurrentInstruction PseudoCode Function

CoprocessorOperation

The CoprocessorOperation function performs the specified Coprocessor operation.

```
CoprocessorOperation (z, cop_fun)

/* z:          Coprocessor unit number */
/* cop_fun:    Coprocessor function from function field of instruction */

/* Transmit the cop_fun value to coprocessor z */

endfunction CoprocessorOperation
```

Figure 2-24 CoprocessorOperation Pseudocode Function

JumpDelaySlot

The JumpDelaySlot function is used in the pseudocode for the four PC-relative instructions. The function returns TRUE if the instruction at *vAddr* is executed in a jump delay slot. A jump delay slot always immediately follows a JR, JAL, JALR, or JALX instruction.

```
JumpDelaySlot(vAddr)

/* vAddr:Virtual address */

endfunction JumpDelaySlot
```

Figure 2-25 JumpDelaySlot Pseudocode Function

FPConditionCode

The FPConditionCode function returns the value of a specific floating point condition code.

```

tf ← FPConditionCode(cc)

/* tf: The value of the specified condition code */

/* cc: The Condition code number in the range 0..7 */

if cc = 0 then
    FPConditionCode ← FCSR23
else
    FPConditionCode ← FCSR24+cc
endif

endfunction FPConditionCode

```

Figure 2-26 FPConditionCode Pseudocode Function

SetFPConditionCode

The SetFPConditionCode function writes a new value to a specific floating point condition code.

```

SetFPConditionCode(cc)
    if cc = 0 then
        FCSR ← FCSR31..24 || tf || FCSR22..0
    else
        FCSR ← FCSR31..25+cc || tf || FCSR23+cc..0
    endif
endfunction SetFPConditionCode

```

Figure 2-27 SetFPConditionCode Pseudocode Function

2.3 Op and Function Subfield Notation

In some instructions, the instruction subfields *op* and *function* can have constant 5- or 6-bit values. When reference is made to these instructions, uppercase mnemonics are used. For instance, in the floating point ADD instruction, *op*=COP1 and *function*=ADD. In other cases, a single field has both fixed and variable subfields, so the name contains both upper- and lowercase characters.

2.4 FPU Instructions

In the detailed description of each FPU instruction, all variable subfields in an instruction format (such as *fs*, *ft*, *immediate*, and so on) are shown in lowercase. The instruction name (such as ADD, SUB, and so on) is shown in uppercase.

For the sake of clarity, an alias is sometimes used for a variable subfield in the formats of specific instructions. For example, *rs=base* in the format for load and store instructions. Such an alias is always lowercase since it refers to a variable subfield.

Bit encodings for mnemonics are given in Volume I, in the chapters describing the CPU, FPU, MDMX, and MIPS16 instructions.

See Section 2.3 , "Op and Function Subfield Notation" on page 20 for a description of the *op* and *function* subfields.

The MIPS32™ Instruction Set

3.1 Compliance and Subsetting

To be compliant with the MIPS32 Architecture, designs must implement a set of required features, as described in this document set. To allow flexibility in implementations, the MIPS32 Architecture does provide subsetting rules. An implementation that follows these rules is compliant with the MIPS32 Architecture as long as it adheres strictly to the rules, and fully implements the remaining instructions.

The instruction set subsetting rules are as follows:

- All CPU instructions must be implemented - no subsetting is allowed.
- The FPU and related support instructions, including the MOVF and MOVT CPU instructions, may be omitted. Software may determine if an FPU is implemented by checking the state of the FP bit in the *Config1* CP0 register. If the FPU is implemented, it must include S, D, and W formats, operate instructions, and all supporting instructions. Software may determine which FPU data types are implemented by checking the appropriate bit in the *FIR* CP1 register. The following allowable FPU subsets are compliant with the MIPS32 architecture:
 - No FPU
 - FPU with S, D, and W formats and all supporting instructions
 -
- Coprocessor 2 is optional and may be omitted. Software may determine if Coprocessor 2 is implemented by checking the state of the C2 bit in the *Config1* CP0 register. If Coprocessor 2 is implemented, the Coprocessor 2 interface instructions (BC2, CFC2, COP2, CTC2, LDC2, LWC2, MFC2, MTC2, SDC2, and SWC2) may be omitted on an instruction by instruction basis.
- Instruction fields that are marked “Reserved” or shown as “0” in the description of that field are reserved for future use by the architecture and are not available to implementations. Implementations may only use those fields that are explicitly reserved for implementation dependent use.
- Supported ASEs are optional and may be subsetting out. In most cases, software may determine if a supported ASE is implemented by checking the appropriate bit in the *Config1* or *Config3* CP0 register. If they are implemented, they must implement the entire ISA applicable to the component, or implement subsets that are approved by the ASE specifications.
- If any instruction is subsetting out based on the rules above, an attempt to execute that instruction must cause the appropriate exception (typically Reserved Instruction or Coprocessor Unusable).

Supersetting of the MIPS32 ISA is only allowed by adding functions to the *SPECIAL2* major opcode or by adding instructions to support Coprocessor 2.

3.2 Alphabetical List of Instructions

Table 3-1 through Table 3-23 provide a list of instructions grouped by category. Individual instruction descriptions follow the tables, arranged in alphabetical order.

Table 3-1 CPU Arithmetic Instructions

Mnemonic	Instruction
ADD	Add Word
ADDI	Add Immediate Word
ADDIU	Add Immediate Unsigned Word
ADDU	Add Unsigned Word
CLO	Count Leading Ones in Word
CLZ	Count Leading Zeros in Word
DIV	Divide Word
DIVU	Divide Unsigned Word
MADD	Multiply and Add Word to Hi, Lo
MADDU	Multiply and Add Unsigned Word to Hi, Lo
MSUB	Multiply and Subtract Word to Hi, Lo
MSUBU	Multiply and Subtract Unsigned Word to Hi, Lo
MUL	Multiply Word to GPR
MULT	Multiply Word
MULTU	Multiply Unsigned Word
SLT	Set on Less Than
SLTI	Set on Less Than Immediate
SLTIU	Set on Less Than Immediate Unsigned
SLTU	Set on Less Than Unsigned
SUB	Subtract Word
SUBU	Subtract Unsigned Word

Table 3-2 CPU Branch and Jump Instructions

Mnemonic	Instruction
B	Unconditional Branch
BAL	Branch and Link
BEQ	Branch on Equal
BGEZ	Branch on Greater Than or Equal to Zero
BGEZAL	Branch on Greater Than or Equal to Zero and Link
BGTZ	Branch on Greater Than Zero
BLEZ	Branch on Less Than or Equal to Zero
BLTZ	Branch on Less Than Zero

Table 3-2 CPU Branch and Jump Instructions

Mnemonic	Instruction
BLTZAL	Branch on Less Than Zero and Link
BNE	Branch on Not Equal
J	Jump
JAL	Jump and Link
JALR	Jump and Link Register
JR	Jump Register

Table 3-3 CPU Instruction Control Instructions

Mnemonic	Instruction
NOP	No Operation
SSNOP	Superscalar No Operation

Table 3-4 CPU Load, Store, and Memory Control Instructions

Mnemonic	Instruction
LB	Load Byte
LBU	Load Byte Unsigned
LH	Load Halfword
LHU	Load Halfword Unsigned
LL	Load Linked Word
LW	Load Word
LWL	Load Word Left
LWR	Load Word Right
PREF	Prefetch
SB	Store Byte
SC	Store Conditional Word
SD	Store Doubleword
SH	Store Halfword
SW	Store Word
SWL	Store Word Left
SWR	Store Word Right
SYNC	Synchronize Shared Memory

Table 3-5 CPU Logical Instructions

Mnemonic	Instruction
AND	And
ANDI	And Immediate
LUI	Load Upper Immediate
NOR	Not Or
OR	Or
ORI	Or Immediate
XOR	Exclusive Or
XORI	Exclusive Or Immediate

Table 3-6 CPU Move Instructions

Mnemonic	Instruction
MFHI	Move From HI Register
MFLO	Move From LO Register
MOVF	Move Conditional on Floating Point False
MOVN	Move Conditional on Not Zero
MOVT	Move Conditional on Floating Point True
MOVZ	Move Conditional on Zero
MTHI	Move To HI Register
MTLO	Move To LO Register

Table 3-7 CPU Shift Instructions

Mnemonic	Instruction
SLL	Shift Word Left Logical
SLLV	Shift Word Left Logical Variable
SRA	Shift Word Right Arithmetic
SRAV	Shift Word Right Arithmetic Variable
SRL	Shift Word Right Logical
SRLV	Shift Word Right Logical Variable

Table 3-8 CPU Trap Instructions

Mnemonic	Instruction
BREAK	Breakpoint
SYSCALL	System Call
TEQ	Trap if Equal
TEQI	Trap if Equal Immediate
TGE	Trap if Greater or Equal
TGEI	Trap if Greater of Equal Immediate
TGEIU	Trap if Greater or Equal Immediate Unsigned
TGEU	Trap if Greater or Equal Unsigned
TLT	Trap if Less Than
TLTI	Trap if Less Than Immediate
TLTIU	Trap if Less Than Immediate Unsigned
TLTU	Trap if Less Than Unsigned
TNE	Trap if Not Equal
TNEI	Trap if Not Equal Immediate

Table 3-9 Obsolete^a CPU Branch Instructions

Mnemonic	Instruction
BEQL	Branch on Equal Likely
BGEZALL	Branch on Greater Than or Equal to Zero and Link Likely
BGEZL	Branch on Greater Than or Equal to Zero Likely
BGTZL	Branch on Greater Than Zero Likely
BLEZL	Branch on Less Than or Equal to Zero Likely
BLTZALL	Branch on Less Than Zero and Link Likely
BLTZL	Branch on Less Than Zero Likely
BNEL	Branch on Not Equal Likely

- a. Software is strongly encouraged to avoid use of the Branch Likely instructions, as they will be removed from a future revision of the MIPS32 architecture.

Table 3-10 FPU Arithmetic Instructions

Mnemonic	Instruction
ABS.fmt	Floating Point Absolute Value
ADD.fmt	Floating Point Add
DIV.fmt	Floating Point Divide
MADD.fmt	Floating Point Multiply Add
MSUB.fmt	Floating Point Multiply Subtract
MUL.fmt	Floating Point Multiply
NEG.fmt	Floating Point Negate
NMADD.fmt	Floating Point Negative Multiply Add
NMSUB.fmt	Floating Point Negative Multiply Subtract
RECIP.fmt	Reciprocal Approximation
RSQRT.fmt	Reciprocal Square Root Approximation
SQRT	Floating Point Square Root
SUB.fmt	Floating Point Subtract

Table 3-11 FPU Branch Instructions

Mnemonic	Instruction
BCIF	Branch on FP False
BCIT	Branch on FP True

Table 3-12 FPU Compare Instructions

Mnemonic	Instruction
C.cond.fmt	Floating Point Compare

Table 3-13 FPU Convert Instructions

Mnemonic	Instruction
CEIL.W.fmt	Floating Point Ceiling Convert to Word Fixed Point
CVT.D.fmt	Floating Point Convert to Double Floating Point
CVT.S.fmt	Floating Point Convert to Single Floating Point
CVT.W.fmt	Floating Point Convert to Word Fixed Point
FLOOR.W.fmt	Floating Point Floor Convert to Word Fixed Point
ROUND.W.fmt	Floating Point Round to Word Fixed Point
TRUNC.W.fmt	Floating Point Truncate to Word Fixed Point

Table 3-14 FPU Load, Store, and Memory Control Instructions

Mnemonic	Instruction
LDC1	Load Doubleword to Floating Point
LWC1	Load Word to Floating Point
SDC1	Store Doubleword from Floating Point
SWC1	Store Word from Floating Point

Table 3-15 FPU Move Instructions

Mnemonic	Instruction
CFC1	Move Control Word from Floating Point
CTC1	Move Control Word to Floating Point
MFC1	Move Word from Floating Point
MOV.fmt	Floating Point Move
MOV.F.fmt	Floating Point Move Conditional on Floating Point False
MOV.N.fmt	Floating Point Move Conditional on Not Zero
MOV.T.fmt	Floating Point Move Conditional on Floating Point True
MOV.Z.fmt	Floating Point Move Conditional on Zero
MTC1	Move Word to Floating Point

Table 3-16 Obsolete^a FPU Branch Instructions

Mnemonic	Instruction
BC1FL	Branch on FP False Likely
BC1TL	Branch on FP True Likely

a. Software is strongly encouraged to avoid use of the Branch Likely instructions, as they will be removed from a future revision of the MIPS32 architecture.

Table 3-17 Coprocessor Branch Instructions

Mnemonic	Instruction
BC2F	Branch on COP2 False
BC2T	Branch on COP2 True

Table 3-18 Coprocessor Execute Instructions

Mnemonic	Instruction
COP2	Coprocessor Operation to Coprocessor 2

Table 3-19 Coprocessor Load and Store Instructions

Mnemonic	Instruction
LDC2	Load Doubleword to Coprocessor 2
LWC2	Load Word to Coprocessor 2
SDC2	Store Doubleword from Coprocessor 2
SWC2	Store Word from Coprocessor 2

Table 3-20 Coprocessor Move Instructions

Mnemonic	Instruction
CFC2	Move Control Word from Coprocessor 2
CTC2	Move Control Word to Coprocessor 2
MFC2	Move Word from Coprocessor 2
MTC2	Move Word to Coprocessor 2

Table 3-21 Obsolete^a Coprocessor Branch Instructions

Mnemonic	Instruction
BC2FL	Branch on COP2 False Likely
BC2TL	Branch on COP2 True Likely

a. Software is strongly encouraged to avoid use of the Branch Likely instructions, as they will be removed from a future revision of the MIPS32 architecture.

Table 3-22 Privileged Instructions

Mnemonic	Instruction
CACHE	Perform Cache Operation
ERET	Exception Return
MFC0	Move from Coprocessor 0
MTC0	Move to Coprocessor 0
TLBP	Probe TLB for Matching Entry
TLBR	Read Indexed TLB Entry
TLBWI	Write Indexed TLB Entry
TLBWR	Write Random TLB Entry
WAIT	Enter Standby Mode

Table 3-23 EJTAG Instructions

Mnemonic	Instruction
DERET	Debug Exception Return
SDBBP	Software Debug Breakpoint

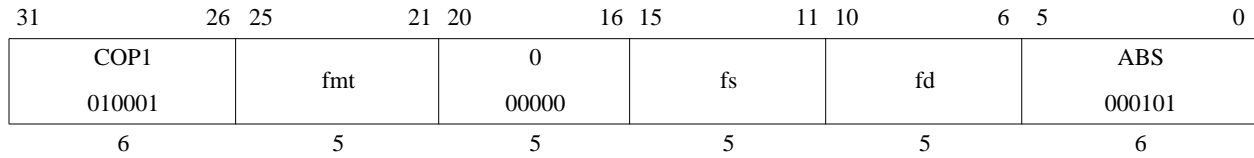

Format: ABS.S fd, fs
 ABS.D fd, fs

MIPS32 (MIPS I)
MIPS32 (MIPS I)

Purpose:

To compute the absolute value of an FP value

Description: $fd \leftarrow \text{abs}(fs)$

The absolute value of the value in FPR *fs* is placed in FPR *fd*. The operand and result are values in format *fmt*. *Cause* bits are ORed into the *Flag* bits if no exception is taken.

This operation is arithmetic; a NaN operand signals invalid operation.

Restrictions:

The fields *fs* and *fd* must specify FPRs valid for operands of type *fmt*. If they are not valid, the result is **UNPREDICTABLE**.

The operand must be a value in format *fmt*; if it is not, the result is **UNPREDICTABLE** and the value of the operand FPR becomes **UNPREDICTABLE**.

Operation:

```
StoreFPR(fd, fmt, AbsoluteValue(ValueFPR(fs, fmt)))
```

Exceptions:

Coprocessor Unusable, Reserved Instruction

Floating Point Exceptions:

Unimplemented Operation, Invalid Operation

31	26 25	21 20	16 15	11 10	6 5	0
SPECIAL 000000	rs	rt	rd	0 00000	ADD 100000	
6	5	5	5	5	6	

Format: ADD *rd*, *rs*, *rt*

MIPS32 (MIPS I)

Purpose:

To add 32-bit integers. If an overflow occurs, then trap.

Description: $rd \leftarrow rs + rt$

The 32-bit word value in GPR *rt* is added to the 32-bit value in GPR *rs* to produce a 32-bit result.

- If the addition results in 32-bit 2's complement arithmetic overflow, the destination register is not modified and an Integer Overflow exception occurs.
- If the addition does not overflow, the 32-bit result is placed into GPR *rd*.

Restrictions:

None

Operation:

```
temp ← (GPR[rs]31 || GPR[rs]31..0) + (GPR[rt]31 || GPR[rt]31..0)
if temp32 ≠ temp31 then
    SignalException(IntegerOverflow)
else
    GPR[rd] ← temp
endif
```

Exceptions:

Integer Overflow

Programming Notes:

ADDU performs the same arithmetic operation but does not trap on overflow.

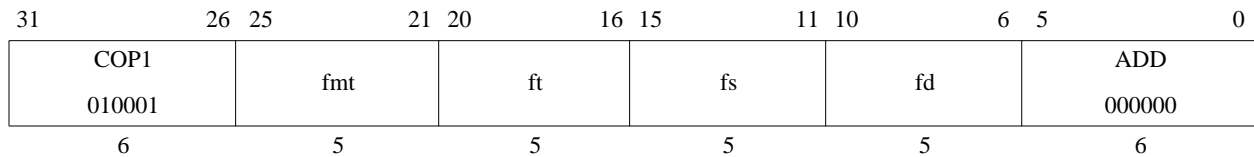

Format: ADD.S *fd, fs, ft*
ADD.D *fd, fs, ft*

MIPS32 (MIPS I)
MIPS32 (MIPS I)

Purpose:

To add floating point values

Description: $fd \leftarrow fs + ft$

The value in FPR *ft* is added to the value in FPR *fs*. The result is calculated to infinite precision, rounded by using to the current rounding mode in *FCSR*, and placed into FPR *fd*. The operands and result are values in format *fmt*. *Cause* bits are ORed into the *Flag* bits if no exception is taken.

Restrictions:

The fields *fs*, *ft*, and *fd* must specify FPRs valid for operands of type *fmt*. If they are not valid, the result is **UNPREDICTABLE**.

The operands must be values in format *fmt*; if they are not, the result is **UNPREDICTABLE** and the value of the operand FPRs becomes **UNPREDICTABLE**.

Operation:

`StoreFPR (fd, fmt, ValueFPR(fs, fmt) +fmt ValueFPR(ft, fmt))`

Exceptions:

Coprocessor Unusable, Reserved Instruction

Floating Point Exceptions:

Unimplemented Operation, Invalid Operation, Inexact, Overflow, Underflow

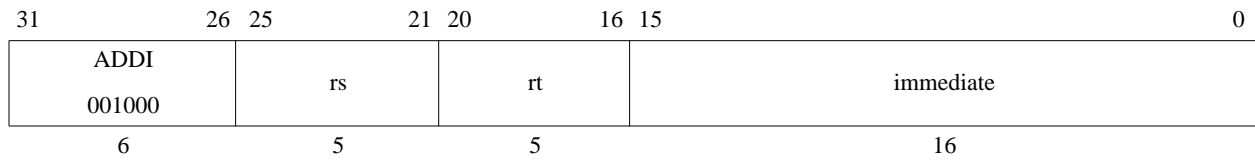

Format: ADDI *rt*, *rs*, *immediate*

MIPS32 (MIPS I)

Purpose:

To add a constant to a 32-bit integer. If overflow occurs, then trap.

Description: $rt \leftarrow rs + \text{immediate}$

The 16-bit signed *immediate* is added to the 32-bit value in GPR *rs* to produce a 32-bit result.

- If the addition results in 32-bit 2's complement arithmetic overflow, the destination register is not modified and an Integer Overflow exception occurs.
- If the addition does not overflow, the 32-bit result is placed into GPR *rt*.

Restrictions:

None

Operation:

```
temp ← (GPR[rs]31 || GPR[rs]31..0) + sign_extend(immediate)
if temp32 ≠ temp31 then
    SignalException(IntegerOverflow)
else
    GPR[rt] ← temp
endif
```

Exceptions:

Integer Overflow

Programming Notes:

ADDIU performs the same arithmetic operation but does not trap on overflow.

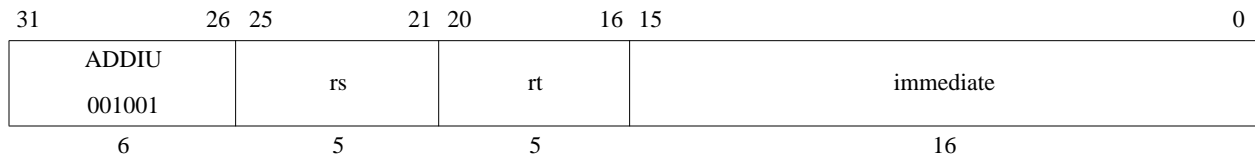

Format: ADDIU *rt*, *rs*, *immediate*

MIPS32 (MIPS I)

Purpose:

To add a constant to a 32-bit integer

Description: $rt \leftarrow rs + immediate$

The 16-bit signed *immediate* is added to the 32-bit value in GPR *rs* and the 32-bit arithmetic result is placed into GPR *rt*.

No Integer Overflow exception occurs under any circumstances.

Restrictions:

None

Operation:

```
temp ← GPR[rs] + sign_extend(immediate)
GPR[rt] ← temp
```

Exceptions:

None

Programming Notes:

The term “unsigned” in the instruction name is a misnomer; this operation is 32-bit modulo arithmetic that does not trap on overflow. This instruction is appropriate for unsigned arithmetic, such as address arithmetic, or integer arithmetic environments that ignore overflow, such as C language arithmetic.

Add Unsigned Word**ADDU**

31	26 25	21 20	16 15	11 10	6 5	0
SPECIAL 000000	rs	rt	rd	0 00000	ADDU 100001	
6	5	5	5	5	6	

Format: ADDU rd, rs, rt**MIPS32 (MIPS I)****Purpose:**

To add 32-bit integers

Description: $rd \leftarrow rs + rt$

The 32-bit word value in GPR *rt* is added to the 32-bit value in GPR *rs* and the 32-bit arithmetic result is placed into GPR *rd*.

No Integer Overflow exception occurs under any circumstances.

Restrictions:

None

Operation:

```
temp ← GPR[rs] + GPR[rt]
GPR[rd] ← temp
```

Exceptions:

None

Programming Notes:

The term “unsigned” in the instruction name is a misnomer; this operation is 32-bit modulo arithmetic that does not trap on overflow. This instruction is appropriate for unsigned arithmetic, such as address arithmetic, or integer arithmetic environments that ignore overflow, such as C language arithmetic.

31	26 25	21 20	16 15	11 10	6 5	0
SPECIAL 000000	rs	rt	rd	0 00000	AND 100100	
6	5	5	5	5	6	

Format: AND *rd*, *rs*, *rt*

MIPS32 (MIPS I)

Purpose:

To do a bitwise logical AND

Description: $rd \leftarrow rs \text{ AND } rt$

The contents of GPR *rs* are combined with the contents of GPR *rt* in a bitwise logical AND operation. The result is placed into GPR *rd*.

Restrictions:

None

Operation:

$GPR[rd] \leftarrow GPR[rs] \text{ and } GPR[rt]$

Exceptions:

None

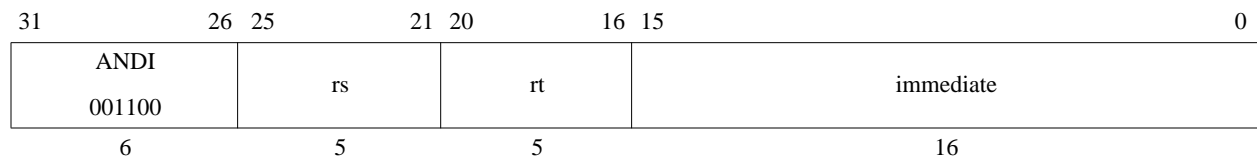

Format: ANDI *rt*, *rs*, *immediate*

MIPS32 (MIPS I)

Purpose:

To do a bitwise logical AND with a constant

Description: $rt \leftarrow rs \text{ AND } immediate$

The 16-bit *immediate* is zero-extended to the left and combined with the contents of GPR *rs* in a bitwise logical AND operation. The result is placed into GPR *rt*.

Restrictions:

None

Operation:

$GPR[rt] \leftarrow GPR[rs] \text{ and } zero_extend(immediate)$

Exceptions:

None

Unconditional Branch

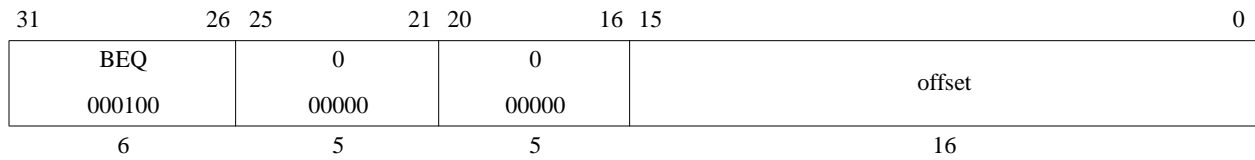
B

Format: B offset

Assembly Idiom

Purpose:

To do an unconditional branch

Description: branch

B offset is the assembly idiom used to denote an unconditional branch. The actual instruction is interpreted by the hardware as BEQ r0, r0, offset.

An 18-bit signed offset (the 16-bit *offset* field shifted left 2 bits) is added to the address of the instruction following the branch (not the branch itself), in the branch delay slot, to form a PC-relative effective target address.

Restrictions:

Processor operation is **UNPREDICTABLE** if a branch, jump, ERET, DERET, or WAIT instruction is placed in the delay slot of a branch or jump.

Operation:

```
I:   target_offset ← sign_extend(offset || 02)
I+1: PC ← PC + target_offset
```

Exceptions:

None

Programming Notes:

With the 18-bit signed instruction offset, the conditional branch range is ± 128 Kbytes. Use jump (J) or jump register (JR) instructions to branch to addresses outside this range.

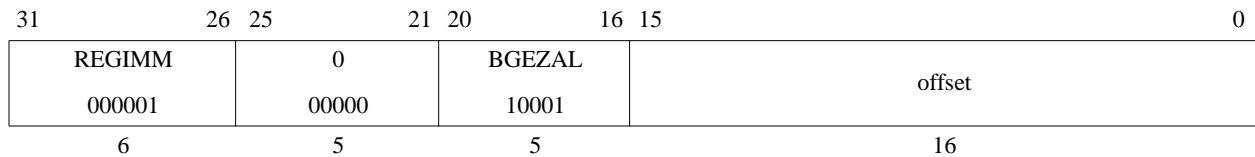

Format: BAL *rs*, *offset*

Assembly Idiom

Purpose:

To do an unconditional PC-relative procedure call

Description: `procedure_call`

BAL *offset* is the assembly idiom used to denote an unconditional branch. The actual instruction is interpreted by the hardware as BGEZAL *r0*, *offset*.

Place the return address link in GPR 31. The return link is the address of the second instruction following the branch, where execution continues after a procedure call.

An 18-bit signed offset (the 16-bit *offset* field shifted left 2 bits) is added to the address of the instruction following the branch (not the branch itself), in the branch delay slot, to form a PC-relative effective target address.

Restrictions:

Processor operation is **UNPREDICTABLE** if a branch, jump, ERET, DERET, or WAIT instruction is placed in the delay slot of a branch or jump.

GPR 31 must not be used for the source register *rs*, because such an instruction does not have the same effect when reexecuted. The result of executing such an instruction is **UNPREDICTABLE**. This restriction permits an exception handler to resume execution by reexecuting the branch when an exception occurs in the branch delay slot.

Operation:

```

I:   target_offset ← sign_extend(offset || 02)
        GPR[31] ← PC + 8
I+1: PC ← PC + target_offset

```

Exceptions:

None

Programming Notes:

With the 18-bit signed instruction *offset*, the conditional branch range is ± 128 KBytes. Use jump and link (JAL) or jump and link register (JALR) instructions for procedure calls to addresses outside this range.

31	26 25	21 20	18 17 16 15	0
COP1	BC	cc	nd tf	offset
010001	01000		0 0	
6	5	3	1 1	16

Format: BC1F offset (cc = 0 implied)
 BC1F cc, offset

MIPS32 (MIPS I)
MIPS32 (MIPS IV)

Purpose:

To test an FP condition code and do a PC-relative conditional branch

Description: if cc = 0 then branch

An 18-bit signed offset (the 16-bit *offset* field shifted left 2 bits) is added to the address of the instruction following the branch (not the branch itself) in the branch delay slot to form a PC-relative effective target address. If the FP condition code bit *CC* is false (0), the program branches to the effective target address after the instruction in the delay slot is executed. An FP condition code is set by the FP compare instruction, C.cond.fmt.

Restrictions:

Processor operation is **UNPREDICTABLE** if a branch, jump, ERET, DERET, or WAIT instruction is placed in the delay slot of a branch or jump.

Operation:

This operation specification is for the general Branch On Condition operation with the *tf* (true/false) and *nd* (nullify delay slot) fields as variables. The individual instructions BC1F, BC1FL, BC1T, and BC1TL have specific values for *tf* and *nd*.

```

I:    condition ← FPConditionCode(cc) = 0
        target_offset ← (offset15)GPRLEN-(16+2) || offset || 02
I+1:  if condition then
        PC ← PC + target_offset
        endif
  
```

Exceptions:

Coprocessor Unusable, Reserved Instruction

Floating Point Exceptions:

Unimplemented Operation

Programming Notes:

With the 18-bit signed instruction offset, the conditional branch range is ± 128 KBytes. Use jump (J) or jump register (JR) instructions to branch to addresses outside this range

Historical Information:

The MIPS I architecture defines a single floating point condition code, implemented as the coprocessor 1 condition signal (*Cp1Cond*) and the *C* bit in the FP *Control/Status* register. MIPS I, II, and III architectures must have the *CC* field set to 0, which is implied by the first format in the “Format” section.

The MIPS IV and MIPS32 architectures add seven more *Condition Code* bits to the original condition code 0. FP compare and conditional branch instructions specify the *Condition Code* bit to set or test. Both assembler formats are valid for MIPS IV and MIPS32.

In the MIPS I, II, and III architectures there must be at least one instruction between the compare instruction that sets the condition code and the branch instruction that tests it. Hardware does not detect a violation of this restriction.

31	26 25	21 20	18 17 16 15	0
COP1	BC	cc	nd tf	offset
010001	01000		1 0	
6	5	3	1 1	16

Format: BC1FL offset (cc = 0 implied)
 BC1FL cc, offset

MIPS32 (MIPS II)
MIPS32 (MIPS IV)

Purpose:

To test an FP condition code and make a PC-relative conditional branch; execute the instruction in the delay slot only if the branch is taken.

Description: if cc = 0 then branch_likely

An 18-bit signed offset (the 16-bit *offset* field shifted left 2 bits) is added to the address of the instruction following the branch (not the branch itself) in the branch delay slot to form a PC-relative effective target address. If the FP *Condition Code* bit *CC* is false (0), the program branches to the effective target address after the instruction in the delay slot is executed. If the branch is not taken, the instruction in the delay slot is not executed.

An FP condition code is set by the FP compare instruction, C.cond.fmt.

Restrictions:

Processor operation is **UNPREDICTABLE** if a branch, jump, ERET, DERET, or WAIT instruction is placed in the delay slot of a branch or jump.

Operation:

This operation specification is for the general Branch On Condition operation with the *tf* (true/false) and *nd* (nullify delay slot) fields as variables. The individual instructions BC1F, BC1FL, BC1T, and BC1TL have specific values for *tf* and *nd*.

```

I:    condition ← FPConditionCode(cc) = 0
        target_offset ← (offset15)GPRLEN-(16+2) || offset || 02
I+1:  if condition then
          PC ← PC + target_offset
        else
          NullifyCurrentInstruction()
        endif
  
```

Exceptions:

Coprocessor Unusable, Reserved Instruction

Floating Point Exceptions:

Unimplemented Operation

Programming Notes:

With the 18-bit signed instruction offset, the conditional branch range is ± 128 KBytes. Use jump (J) or jump register (JR) instructions to branch to addresses outside this range.

Software is strongly encouraged to avoid the use of the Branch Likely instructions, as they will be removed from a future revision of the MIPS Architecture.

Some implementations always predict the branch will be taken, so there is a significant penalty if the branch is not taken. Software should only use this instruction when there is a very high probability (98% or more) that the branch will be taken. If the branch is not likely to be taken or if the probability of a taken branch is unknown, software is encouraged to use the BC1F instruction instead.

Historical Information:

The MIPS I architecture defines a single floating point condition code, implemented as the coprocessor 1 condition signal (*Cp1Cond*) and the *C* bit in the FP *Control/Status* register. MIPS I, II, and III architectures must have the *CC* field set to 0, which is implied by the first format in the “Format” section.

The MIPS IV and MIPS32 architectures add seven more *Condition Code* bits to the original condition code 0. FP compare and conditional branch instructions specify the *Condition Code* bit to set or test. Both assembler formats are valid for MIPS IV and MIPS32.

In the MIPS II and III architectures there must be at least one instruction between the compare instruction that sets a condition code and the branch instruction that tests it. Hardware does not detect a violation of this restriction.

31	26 25	21 20	18 17 16 15	0
COP1	BC	cc	nd tf	offset
010001	01000	0	1 1	0
6	5	3	1 1	16

Format: BC1T offset (cc = 0 implied)
BC1T cc, offset

MIPS32 (MIPS I)
MIPS32 (MIPS IV)

Purpose:

To test an FP condition code and do a PC-relative conditional branch

Description: if cc = 1 then branch

An 18-bit signed offset (the 16-bit *offset* field shifted left 2 bits) is added to the address of the instruction following the branch (not the branch itself) in the branch delay slot to form a PC-relative effective target address. If the FP condition code bit *CC* is true (1), the program branches to the effective target address after the instruction in the delay slot is executed. An FP condition code is set by the FP compare instruction, C.cond.fmt.

Restrictions:

Processor operation is **UNPREDICTABLE** if a branch, jump, ERET, DERET, or WAIT instruction is placed in the delay slot of a branch or jump.

Operation:

This operation specification is for the general Branch On Condition operation with the *tf* (true/false) and *nd* (nullify delay slot) fields as variables. The individual instructions BC1F, BC1FL, BC1T, and BC1TL have specific values for *tf* and *nd*.

```

I:    condition ← FPConditionCode(cc) = 1
        target_offset ← (offset15)GPRLEN-(16+2) || offset || 02
I+1:  if condition then
        PC ← PC + target_offset
        endif

```

Exceptions:

Coprocessor Unusable, Reserved Instruction

Floating Point Exceptions:

Unimplemented Operation

Programming Notes:

With the 18-bit signed instruction offset, the conditional branch range is ± 128 KBytes. Use jump (J) or jump register (JR) instructions to branch to addresses outside this range.

Historical Information:

The MIPS I architecture defines a single floating point condition code, implemented as the coprocessor 1 condition signal (*Cp1Cond*) and the *C* bit in the FP *Control/Status* register. MIPS I, II, and III architectures must have the *CC* field set to 0, which is implied by the first format in the “Format” section.

The MIPS IV and MIPS32 architectures add seven more *Condition Code* bits to the original condition code 0. FP compare and conditional branch instructions specify the *Condition Code* bit to set or test. Both assembler formats are valid for MIPS IV and MIPS32.

In the MIPS I, II, and III architectures there must be at least one instruction between the compare instruction that sets the condition code and the branch instruction that tests it. Hardware does not detect a violation of this restriction.

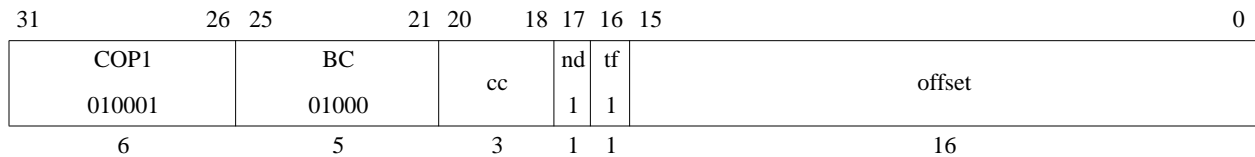

Format: BC1TL offset (cc = 0 implied)
 BC1TL cc, offset

MIPS32 (MIPS II)
MIPS32 (MIPS IV)

Purpose:

To test an FP condition code and do a PC-relative conditional branch; execute the instruction in the delay slot only if the branch is taken.

Description: if cc = 1 then branch_likely

An 18-bit signed offset (the 16-bit *offset* field shifted left 2 bits) is added to the address of the instruction following the branch (not the branch itself) in the branch delay slot to form a PC-relative effective target address. If the FP *Condition Code* bit *CC* is true (1), the program branches to the effective target address after the instruction in the delay slot is executed. If the branch is not taken, the instruction in the delay slot is not executed.

An FP condition code is set by the FP compare instruction, C.cond.fmt.

Restrictions:

Processor operation is **UNPREDICTABLE** if a branch, jump, ERET, DERET, or WAIT instruction is placed in the delay slot of a branch or jump.

Operation:

This operation specification is for the general Branch On Condition operation with the *tf* (true/false) and *nd* (nullify delay slot) fields as variables. The individual instructions BC1F, BC1FL, BC1T, and BC1TL have specific values for *tf* and *nd*.

```

I:    condition ← FPConditionCode(cc) = 1
        target_offset ← (offset15)GPRLEN-(16+2) || offset || 02
I+1: if condition then
        PC ← PC + target_offset
        else
        NullifyCurrentInstruction()
        endif
  
```

Exceptions:

Coprocessor Unusable, Reserved Instruction

Floating Point Exceptions:

Unimplemented Operation

Programming Notes:

With the 18-bit signed instruction offset, the conditional branch range is ± 128 KBytes. Use jump (J) or jump register (JR) instructions to branch to addresses outside this range.

Software is strongly encouraged to avoid the use of the Branch Likely instructions, as they will be removed from a future revision of the MIPS Architecture.

Some implementations always predict the branch will be taken, so there is a significant penalty if the branch is not taken. Software should only use this instruction when there is a very high probability (98% or more) that the branch will be taken. If the branch is not likely to be taken or if the probability of a taken branch is unknown, software is encouraged to use the BC1T instruction instead.

Historical Information:

The MIPS I architecture defines a single floating point condition code, implemented as the coprocessor 1 condition signal (*Cp1Cond*) and the *C* bit in the FP *Control/Status* register. MIPS I, II, and III architectures must have the *CC* field set to 0, which is implied by the first format in the “Format” section.

The MIPS IV and MIPS32 architectures add seven more *Condition Code* bits to the original condition code 0. FP compare and conditional branch instructions specify the *Condition Code* bit to set or test. Both assembler formats are valid for MIPS IV and MIPS32.

In the MIPS II and III architectures there must be at least one instruction between the compare instruction that sets a condition code and the branch instruction that tests it. Hardware does not detect a violation of this restriction.

31	26	25	21	20	18	17	16	15	0
COP2		BC			cc	nd	tf	offset	
010010		01000			0	0			
6		5			3	1	1	16	

Format: BC2F offset (cc = 0 implied)
BC2F cc, offset

MIPS32 (MIPS I)
MIPS32 (MIPS IV)

Purpose:

To test a COP2 condition code and do a PC-relative conditional branch

Description: if cc = 0 then branch

An 18-bit signed offset (the 16-bit *offset* field shifted left 2 bits) is added to the address of the instruction following the branch (not the branch itself) in the branch delay slot to form a PC-relative effective target address. If the COP2 condition specified by *CC* is false (0), the program branches to the effective target address after the instruction in the delay slot is executed.

Restrictions:

Processor operation is **UNPREDICTABLE** if a branch, jump, ERET, DERET, or WAIT instruction is placed in the delay slot of a branch or jump.

Operation:

This operation specification is for the general Branch On Condition operation with the *tf* (true/false) and *nd* (nullify delay slot) fields as variables. The individual instructions BC2F, BC2FL, BC2T, and BC2TL have specific values for *tf* and *nd*.

```

I:    condition ← COP2Condition(cc) = 0
        target_offset ← (offset15)GPRLLEN-(16+2) || offset || 02
I+1:  if condition then
        PC ← PC + target_offset
        endif

```

Exceptions:

Coprocessor Unusable, Reserved Instruction

Programming Notes:

With the 18-bit signed instruction offset, the conditional branch range is ± 128 KBytes. Use jump (J) or jump register (JR) instructions to branch to addresses outside this range.

31	26 25	21 20	18 17 16 15	0
COP2	BC	cc	nd tf	offset
010010	01000		1 0	
6	5	3	1 1	16

Format: BC2FL offset (cc = 0 implied)
BC2FL cc, offset

MIPS32 (MIPS II)
MIPS32 (MIPS IV)

Purpose:

To test a COP2 condition code and make a PC-relative conditional branch; execute the instruction in the delay slot only if the branch is taken.

Description: if cc = 0 then branch_likely

An 18-bit signed offset (the 16-bit *offset* field shifted left 2 bits) is added to the address of the instruction following the branch (not the branch itself) in the branch delay slot to form a PC-relative effective target address. If the COP2 condition specified by *CC* is false (0), the program branches to the effective target address after the instruction in the delay slot is executed. If the branch is not taken, the instruction in the delay slot is not executed.

Restrictions:

Processor operation is **UNPREDICTABLE** if a branch, jump, ERET, DERET, or WAIT instruction is placed in the delay slot of a branch or jump.

Operation:

This operation specification is for the general Branch On Condition operation with the *tf* (true/false) and *nd* (nullify delay slot) fields as variables. The individual instructions BC2F, BC2FL, BC2T, and BC2TL have specific values for *tf* and *nd*.

```

I:    condition ← COP2Condition(cc) = 0
        target_offset ← (offset15)GPRLEN-(16+2) || offset || 02
I+1:  if condition then
        PC ← PC + target_offset
        else
        NullifyCurrentInstruction()
        endif

```

Exceptions:

Coprocessor Unusable, Reserved Instruction

Programming Notes:

With the 18-bit signed instruction offset, the conditional branch range is ± 128 KBytes. Use jump (J) or jump register (JR) instructions to branch to addresses outside this range.

Software is strongly encouraged to avoid the use of the Branch Likely instructions, as they will be removed from a future revision of the MIPS Architecture.

Some implementations always predict the branch will be taken, so there is a significant penalty if the branch is not taken. Software should only use this instruction when there is a very high probability (98% or more) that the branch will be taken. If the branch is not likely to be taken or if the probability of a taken branch is unknown, software is encouraged to use the BC2F instruction instead.

31	26	25	21	20	18	17	16	15	0
COP2		BC			cc	nd	tf	offset	
010010		01000			0	1	1		
6		5			3	1	1	16	

Format: BC2T offset (cc = 0 implied)
BC2T cc, offset

MIPS32 (MIPS I)
MIPS32 (MIPS IV)

Purpose:

To test a COP2 condition code and do a PC-relative conditional branch

Description: if cc = 1 then branch

An 18-bit signed offset (the 16-bit *offset* field shifted left 2 bits) is added to the address of the instruction following the branch (not the branch itself) in the branch delay slot to form a PC-relative effective target address. If the COP2 condition specified by *CC* is true (1), the program branches to the effective target address after the instruction in the delay slot is executed.

Restrictions:

Processor operation is **UNPREDICTABLE** if a branch, jump, ERET, DERET, or WAIT instruction is placed in the delay slot of a branch or jump.

Operation:

This operation specification is for the general Branch On Condition operation with the *tf* (true/false) and *nd* (nullify delay slot) fields as variables. The individual instructions BC2F, BC2FL, BC2T, and BC2TL have specific values for *tf* and *nd*.

```

I:    condition ← COP2Condition(cc) = 1
        target_offset ← (offset15)GPRLLEN-(16+2) || offset || 02
I+1:  if condition then
        PC ← PC + target_offset
        endif

```

Exceptions:

Coprocessor Unusable, Reserved Instruction

Programming Notes:

With the 18-bit signed instruction offset, the conditional branch range is ± 128 KBytes. Use jump (J) or jump register (JR) instructions to branch to addresses outside this range.

31	26 25	21 20	18 17 16 15	0
COP2	BC	cc	nd tf	offset
010010	01000		1 1	
6	5	3	1 1	16

Format: BC2TL offset (cc = 0 implied)
BC2TL cc, offset

MIPS32 (MIPS II)
MIPS32 (MIPS IV)

Purpose:

To test a COP2 condition code and do a PC-relative conditional branch; execute the instruction in the delay slot only if the branch is taken.

Description: if cc = 1 then branch_likely

An 18-bit signed offset (the 16-bit *offset* field shifted left 2 bits) is added to the address of the instruction following the branch (not the branch itself) in the branch delay slot to form a PC-relative effective target address. If the COP2 condition specified by *CC* is true (1), the program branches to the effective target address after the instruction in the delay slot is executed. If the branch is not taken, the instruction in the delay slot is not executed.

Restrictions:

Processor operation is **UNPREDICTABLE** if a branch, jump, ERET, DERET, or WAIT instruction is placed in the delay slot of a branch or jump.

Operation:

This operation specification is for the general Branch On Condition operation with the *tf* (true/false) and *nd* (nullify delay slot) fields as variables. The individual instructions BC2F, BC2FL, BC2T, and BC2TL have specific values for *tf* and *nd*.

```

I:    condition ← COP2Condition(cc) = 1
        target_offset ← (offset15)GPRLEN-(16+2) || offset || 02
I+1:  if condition then
        PC ← PC + target_offset
        else
        NullifyCurrentInstruction()
        endif

```

Exceptions:

Coprocessor Unusable, Reserved Instruction

Programming Notes:

With the 18-bit signed instruction offset, the conditional branch range is ± 128 KBytes. Use jump (J) or jump register (JR) instructions to branch to addresses outside this range.

Software is strongly encouraged to avoid the use of the Branch Likely instructions, as they will be removed from a future revision of the MIPS Architecture.

Some implementations always predict the branch will be taken, so there is a significant penalty if the branch is not taken. Software should only use this instruction when there is a very high probability (98% or more) that the branch will be taken. If the branch is not likely to be taken or if the probability of a taken branch is unknown, software is encouraged to use the BC2T instruction instead.

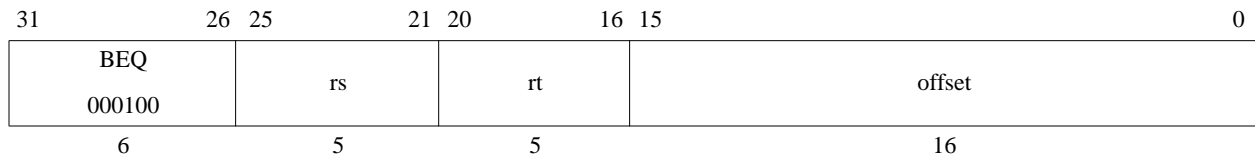

Format: BEQ *rs*, *rt*, *offset*

MIPS32 (MIPS I)

Purpose:

To compare GPRs then do a PC-relative conditional branch

Description: if *rs* = *rt* then branch

An 18-bit signed offset (the 16-bit *offset* field shifted left 2 bits) is added to the address of the instruction following the branch (not the branch itself), in the branch delay slot, to form a PC-relative effective target address.

If the contents of GPR *rs* and GPR *rt* are equal, branch to the effective target address after the instruction in the delay slot is executed.

Restrictions:

Processor operation is **UNPREDICTABLE** if a branch, jump, ERET, DERET, or WAIT instruction is placed in the delay slot of a branch or jump.

Operation:

```

I:    target_offset ← sign_extend(offset || 02)
         condition ← (GPR[rs] = GPR[rt])
I+1:  if condition then
         PC ← PC + target_offset
         endif

```

Exceptions:

None

Programming Notes:

With the 18-bit signed instruction offset, the conditional branch range is ± 128 Kbytes. Use jump (J) or jump register (JR) instructions to branch to addresses outside this range.

BEQ *r0*, *r0* *offset*, expressed as B *offset*, is the assembly idiom used to denote an unconditional branch.

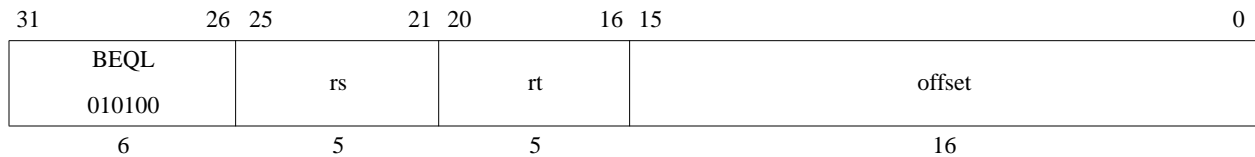

Format: BEQL *rs*, *rt*, *offset*

MIPS32 (MIPS II)

Purpose:

To compare GPRs then do a PC-relative conditional branch; execute the delay slot only if the branch is taken.

Description: if *rs* = *rt* then *branch_likely*

An 18-bit signed offset (the 16-bit *offset* field shifted left 2 bits) is added to the address of the instruction following the branch (not the branch itself), in the branch delay slot, to form a PC-relative effective target address.

If the contents of GPR *rs* and GPR *rt* are equal, branch to the target address after the instruction in the delay slot is executed. If the branch is not taken, the instruction in the delay slot is not executed.

Restrictions:

Processor operation is **UNPREDICTABLE** if a branch, jump, ERET, DERET, or WAIT instruction is placed in the delay slot of a branch or jump.

Operation:

```

I:    target_offset ← sign_extend(offset || 02)
        condition ← (GPR[rs] = GPR[rt])
I+1:  if condition then
        PC ← PC + target_offset
        else
        NullifyCurrentInstruction()
        endif

```

Exceptions:

None

Programming Notes:

With the 18-bit signed instruction offset, the conditional branch range is ± 128 KBytes. Use jump (J) or jump register (JR) instructions to branch to addresses outside this range.

Software is strongly encouraged to avoid the use of the Branch Likely instructions, as they will be removed from a future revision of the MIPS Architecture.

Some implementations always predict the branch will be taken, so there is a significant penalty if the branch is not taken. Software should only use this instruction when there is a very high probability (98% or more) that the branch will be taken. If the branch is not likely to be taken or if the probability of a taken branch is unknown, software is encouraged to use the BEQ instruction instead.

Historical Information:

In the MIPS I architecture, this instruction signaled a Reserved Instruction Exception.

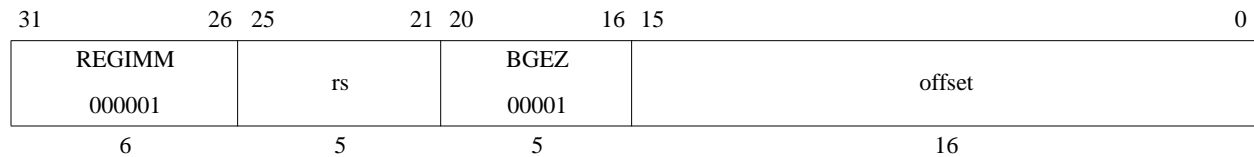

Format: BGEZ *rs*, *offset*

MIPS32 (MIPS I)

Purpose:

To test a GPR then do a PC-relative conditional branch

Description: if $rs \geq 0$ then branch

An 18-bit signed offset (the 16-bit *offset* field shifted left 2 bits) is added to the address of the instruction following the branch (not the branch itself), in the branch delay slot, to form a PC-relative effective target address.

If the contents of GPR *rs* are greater than or equal to zero (sign bit is 0), branch to the effective target address after the instruction in the delay slot is executed.

Restrictions:

Processor operation is **UNPREDICTABLE** if a branch, jump, ERET, DERET, or WAIT instruction is placed in the delay slot of a branch or jump.

Operation:

```

I:    target_offset ← sign_extend(offset || 02)
        condition ← GPR[rs] ≥ 0GPRLEN
I+1: if condition then
        PC ← PC + target_offset
        endif

```

Exceptions:

None

Programming Notes:

With the 18-bit signed instruction offset, the conditional branch range is ± 128 KBytes. Use jump (J) or jump register (JR) instructions to branch to addresses outside this range.

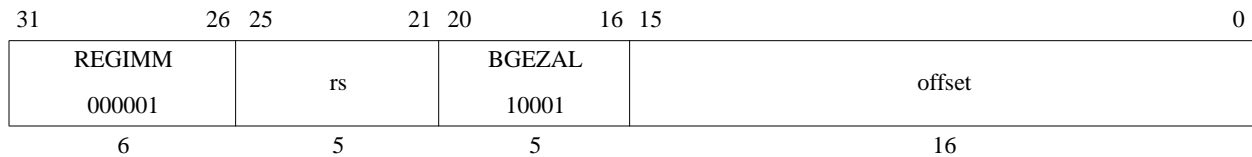

Format: BGEZAL *rs*, *offset*

MIPS32 (MIPS I)

Purpose:

To test a GPR then do a PC-relative conditional procedure call

Description: if $rs \geq 0$ then *procedure_call*

Place the return address link in GPR 31. The return link is the address of the second instruction following the branch, where execution continues after a procedure call.

An 18-bit signed offset (the 16-bit *offset* field shifted left 2 bits) is added to the address of the instruction following the branch (not the branch itself), in the branch delay slot, to form a PC-relative effective target address.

If the contents of GPR *rs* are greater than or equal to zero (sign bit is 0), branch to the effective target address after the instruction in the delay slot is executed.

Restrictions:

Processor operation is **UNPREDICTABLE** if a branch, jump, ERET, DERET, or WAIT instruction is placed in the delay slot of a branch or jump.

GPR 31 must not be used for the source register *rs*, because such an instruction does not have the same effect when reexecuted. The result of executing such an instruction is **UNPREDICTABLE**. This restriction permits an exception handler to resume execution by reexecuting the branch when an exception occurs in the branch delay slot.

Operation:

```

I:    target_offset ← sign_extend(offset || 02)
        condition ← GPR[rs] ≥ 0GPRLEN
        GPR[31] ← PC + 8
I+1:  if condition then
        PC ← PC + target_offset
        endif

```

Exceptions:

None

Programming Notes:

With the 18-bit signed instruction offset, the conditional branch range is ± 128 KBytes. Use jump and link (JAL) or jump and link register (JALR) instructions for procedure calls to addresses outside this range.

BGEZAL *r0*, *offset*, expressed as BAL *offset*, is the assembly idiom used to denote a PC-relative branch and link. BAL is used in a manner similar to JAL, but provides PC-relative addressing and a more limited target PC range.

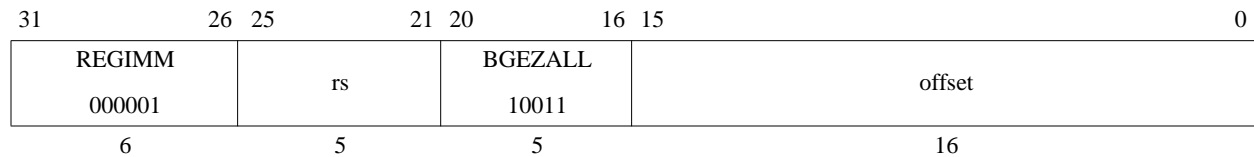

Format: BGEZALL *rs*, *offset*

MIPS32 (MIPS II)

Purpose:

To test a GPR then do a PC-relative conditional procedure call; execute the delay slot only if the branch is taken.

Description: if $rs \geq 0$ then *procedure_call_likely*

Place the return address link in GPR 31. The return link is the address of the second instruction following the branch, where execution continues after a procedure call.

An 18-bit signed offset (the 16-bit *offset* field shifted left 2 bits) is added to the address of the instruction following the branch (not the branch itself), in the branch delay slot, to form a PC-relative effective target address.

If the contents of GPR *rs* are greater than or equal to zero (sign bit is 0), branch to the effective target address after the instruction in the delay slot is executed. If the branch is not taken, the instruction in the delay slot is not executed.

Restrictions:

GPR 31 must not be used for the source register *rs*, because such an instruction does not have the same effect when reexecuted. The result of executing such an instruction is **UNPREDICTABLE**. This restriction permits an exception handler to resume execution by reexecuting the branch when an exception occurs in the branch delay slot.

Processor operation is **UNPREDICTABLE** if a branch, jump, ERET, DERET, or WAIT instruction is placed in the delay slot of a branch or jump.

Operation:

```

I:   target_offset ← sign_extend(offset || 02)
        condition ← GPR[rs] ≥ 0GPRLEN
        GPR[31] ← PC + 8
I+1: if condition then
        PC ← PC + target_offset
        else
        NullifyCurrentInstruction()
        endif

```

Exceptions:

None

Programming Notes:

With the 18-bit signed instruction offset, the conditional branch range is ± 128 KBytes. Use jump and link (JAL) or jump and link register (JALR) instructions for procedure calls to addresses outside this range.

Software is strongly encouraged to avoid the use of the Branch Likely instructions, as they will be removed from a future revision of the MIPS Architecture.

Some implementations always predict the branch will be taken, so there is a significant penalty if the branch is not taken. Software should only use this instruction when there is a very high probability (98% or more) that the branch will be taken. If the branch is not likely to be taken or if the probability of a taken branch is unknown, software is encouraged to use the BGEZAL instruction instead.

Historical Information:

In the MIPS I architecture, this instruction signaled a Reserved Instruction Exception.

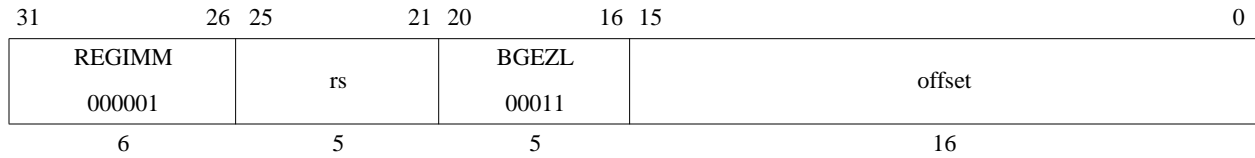

Format: BGEZL *rs*, *offset*

MIPS32 (MIPS II)

Purpose:

To test a GPR then do a PC-relative conditional branch; execute the delay slot only if the branch is taken.

Description: if $rs \geq 0$ then *branch_likely*

An 18-bit signed offset (the 16-bit *offset* field shifted left 2 bits) is added to the address of the instruction following the branch (not the branch itself), in the branch delay slot, to form a PC-relative effective target address.

If the contents of GPR *rs* are greater than or equal to zero (sign bit is 0), branch to the effective target address after the instruction in the delay slot is executed. If the branch is not taken, the instruction in the delay slot is not executed.

Restrictions:

Processor operation is **UNPREDICTABLE** if a branch, jump, ERET, DERET, or WAIT instruction is placed in the delay slot of a branch or jump.

Operation:

```

I:    target_offset ← sign_extend(offset || 02)
        condition ← GPR[rs] ≥ 0GPRLEN
I+1: if condition then
        PC ← PC + target_offset
        else
        NullifyCurrentInstruction()
        endif

```

Exceptions:

None

Programming Notes:

With the 18-bit signed instruction offset, the conditional branch range is ± 128 KBytes. Use jump (J) or jump register (JR) instructions to branch to addresses outside this range.

Software is strongly encouraged to avoid the use of the Branch Likely instructions, as they will be removed from a future revision of the MIPS Architecture.

Some implementations always predict the branch will be taken, so there is a significant penalty if the branch is not taken. Software should only use this instruction when there is a very high probability (98% or more) that the branch will be taken. If the branch is not likely to be taken or if the probability of a taken branch is unknown, software is encouraged to use the BGEZ instruction instead.

Historical Information:

In the MIPS I architecture, this instruction signaled a Reserved Instruction Exception.

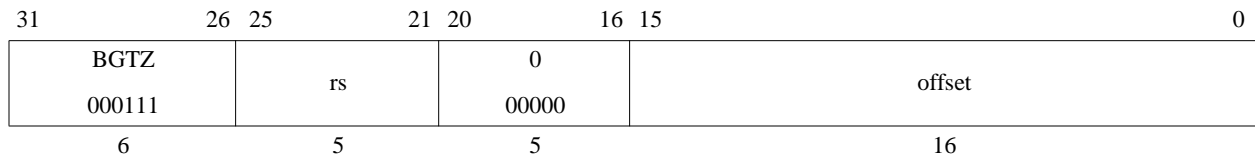

Format: BGTZ *rs*, *offset*

MIPS32 (MIPS I)

Purpose:

To test a GPR then do a PC-relative conditional branch

Description: if $rs > 0$ then branch

An 18-bit signed offset (the 16-bit *offset* field shifted left 2 bits) is added to the address of the instruction following the branch (not the branch itself), in the branch delay slot, to form a PC-relative effective target address.

If the contents of GPR *rs* are greater than zero (sign bit is 0 but value not zero), branch to the effective target address after the instruction in the delay slot is executed.

Restrictions:

Processor operation is **UNPREDICTABLE** if a branch, jump, ERET, DERET, or WAIT instruction is placed in the delay slot of a branch or jump.

Operation:

```

I:    target_offset ← sign_extend(offset || 02)
        condition ← GPR[rs] > 0GPRLEN
I+1:  if condition then
        PC ← PC + target_offset
        endif

```

Exceptions:

None

Programming Notes:

With the 18-bit signed instruction offset, the conditional branch range is ± 128 KBytes. Use jump (J) or jump register (JR) instructions to branch to addresses outside this range.

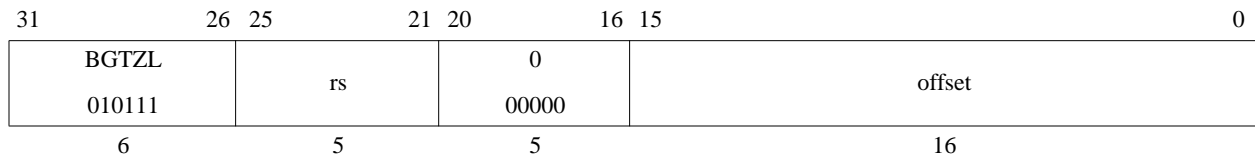

Format: BGTZL *rs*, *offset*

MIPS32 (MIPS II)

Purpose:

To test a GPR then do a PC-relative conditional branch; execute the delay slot only if the branch is taken.

Description: if $rs > 0$ then *branch_likely*

An 18-bit signed offset (the 16-bit *offset* field shifted left 2 bits) is added to the address of the instruction following the branch (not the branch itself), in the branch delay slot, to form a PC-relative effective target address.

If the contents of GPR *rs* are greater than zero (sign bit is 0 but value not zero), branch to the effective target address after the instruction in the delay slot is executed. If the branch is not taken, the instruction in the delay slot is not executed.

Restrictions:

Processor operation is **UNPREDICTABLE** if a branch, jump, ERET, DERET, or WAIT instruction is placed in the delay slot of a branch or jump.

Operation:

```

I:    target_offset ← sign_extend(offset || 02)
        condition ← GPR[rs] > 0GPRLEN
I+1:  if condition then
        PC ← PC + target_offset
        else
        NullifyCurrentInstruction()
        endif

```

Exceptions:

None

Programming Notes:

With the 18-bit signed instruction offset, the conditional branch range is ± 128 KBytes. Use jump (J) or jump register (JR) instructions to branch to addresses outside this range.

Software is strongly encouraged to avoid the use of the Branch Likely instructions, as they will be removed from a future revision of the MIPS Architecture.

Some implementations always predict the branch will be taken, so there is a significant penalty if the branch is not taken. Software should only use this instruction when there is a very high probability (98% or more) that the branch will be taken. If the branch is not likely to be taken or if the probability of a taken branch is unknown, software is encouraged to use the BGTZ instruction instead.

Historical Information:

In the MIPS I architecture, this instruction signaled a Reserved Instruction Exception.

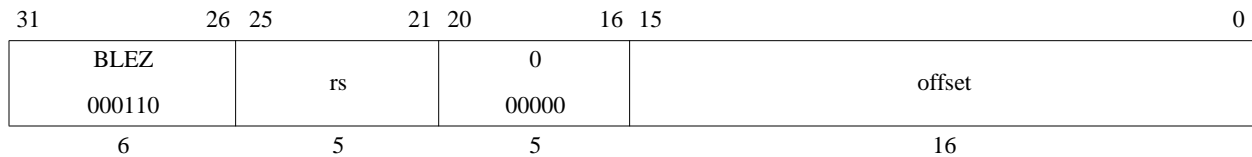

Format: BLEZ *rs*, *offset*

MIPS32 (MIPS I)

Purpose:

To test a GPR then do a PC-relative conditional branch

Description: if $rs \leq 0$ then branch

An 18-bit signed offset (the 16-bit *offset* field shifted left 2 bits) is added to the address of the instruction following the branch (not the branch itself), in the branch delay slot, to form a PC-relative effective target address.

If the contents of GPR *rs* are less than or equal to zero (sign bit is 1 or value is zero), branch to the effective target address after the instruction in the delay slot is executed.

Restrictions:

Processor operation is **UNPREDICTABLE** if a branch, jump, ERET, DERET, or WAIT instruction is placed in the delay slot of a branch or jump.

Operation:

```

I:    target_offset ← sign_extend(offset || 02)
        condition ← GPR[rs] ≤ 0GPRLEN
I+1:  if condition then
        PC ← PC + target_offset
        endif

```

Exceptions:

None

Programming Notes:

With the 18-bit signed instruction offset, the conditional branch range is ± 128 KBytes. Use jump (J) or jump register (JR) instructions to branch to addresses outside this range.

31	26 25	21 20	16 15	0
BLEZL 010110	rs	0 00000	offset	
6	5	5	16	

Format: BLEZL rs, offset

MIPS32 (MIPS II)

Purpose:

To test a GPR then do a PC-relative conditional branch; execute the delay slot only if the branch is taken.

Description: if $rs \leq 0$ then branch_likely

An 18-bit signed offset (the 16-bit *offset* field shifted left 2 bits) is added to the address of the instruction following the branch (not the branch itself), in the branch delay slot, to form a PC-relative effective target address.

If the contents of GPR *rs* are less than or equal to zero (sign bit is 1 or value is zero), branch to the effective target address after the instruction in the delay slot is executed. If the branch is not taken, the instruction in the delay slot is not executed.

Restrictions:

Processor operation is **UNPREDICTABLE** if a branch, jump, ERET, DERET, or WAIT instruction is placed in the delay slot of a branch or jump.

Operation:

```

I:    target_offset ← sign_extend(offset || 02)
        condition ← GPR[rs] ≤ 0GPRLEN
I+1: if condition then
        PC ← PC + target_offset
        else
        NullifyCurrentInstruction()
        endif

```

Exceptions:

None

Programming Notes:

With the 18-bit signed instruction offset, the conditional branch range is ± 128 KBytes. Use jump (J) or jump register (JR) instructions to branch to addresses outside this range.

Software is strongly encouraged to avoid the use of the Branch Likely instructions, as they will be removed from a future revision of the MIPS Architecture.

Some implementations always predict the branch will be taken, so there is a significant penalty if the branch is not taken. Software should only use this instruction when there is a very high probability (98% or more) that the branch will be taken. If the branch is not likely to be taken or if the probability of a taken branch is unknown, software is encouraged to use the BLEZ instruction instead.

Historical Information:

In the MIPS I architecture, this instruction signaled a Reserved Instruction Exception.

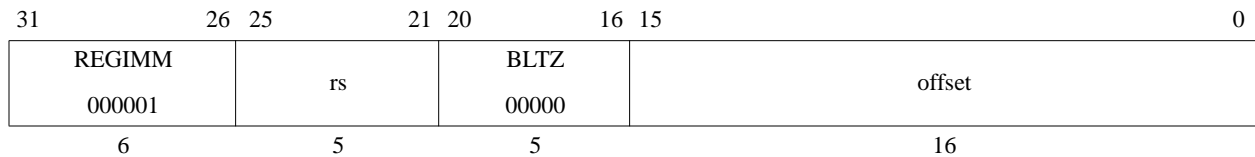

Format: BLTZ *rs*, *offset*

MIPS32 (MIPS I)

Purpose:

To test a GPR then do a PC-relative conditional branch

Description: if $rs < 0$ then branch

An 18-bit signed offset (the 16-bit *offset* field shifted left 2 bits) is added to the address of the instruction following the branch (not the branch itself), in the branch delay slot, to form a PC-relative effective target address.

If the contents of GPR *rs* are less than zero (sign bit is 1), branch to the effective target address after the instruction in the delay slot is executed.

Restrictions:

Processor operation is **UNPREDICTABLE** if a branch, jump, ERET, DERET, or WAIT instruction is placed in the delay slot of a branch or jump.

Operation:

```

I:    target_offset ← sign_extend(offset || 02)
        condition ← GPR[rs] < 0GPRLEN
I+1:  if condition then
        PC ← PC + target_offset
        endif

```

Exceptions:

None

Programming Notes:

With the 18-bit signed instruction offset, the conditional branch range is ± 128 KBytes. Use jump and link (JAL) or jump and link register (JALR) instructions for procedure calls to addresses outside this range.

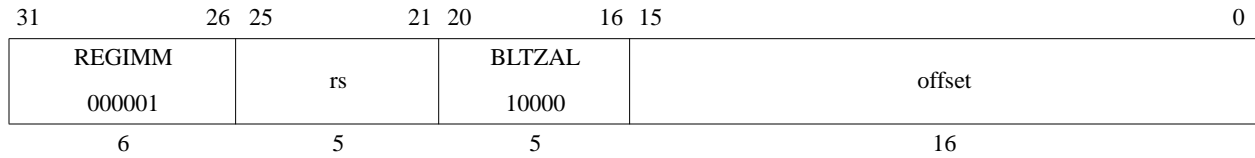

Format: BLTZAL *rs*, *offset*

MIPS32 (MIPS I)

Purpose:

To test a GPR then do a PC-relative conditional procedure call

Description: if *rs* < 0 then *procedure_call*

Place the return address link in GPR 31. The return link is the address of the second instruction following the branch, where execution continues after a procedure call.

An 18-bit signed offset (the 16-bit *offset* field shifted left 2 bits) is added to the address of the instruction following the branch (not the branch itself), in the branch delay slot, to form a PC-relative effective target address.

If the contents of GPR *rs* are less than zero (sign bit is 1), branch to the effective target address after the instruction in the delay slot is executed.

Restrictions:

GPR 31 must not be used for the source register *rs*, because such an instruction does not have the same effect when reexecuted. The result of executing such an instruction is UNPREDICTABLE. This restriction permits an exception handler to resume execution by reexecuting the branch when an exception occurs in the branch delay slot.

Processor operation is **UNPREDICTABLE** if a branch, jump, ERET, DERET, or WAIT instruction is placed in the delay slot of a branch or jump.

Operation:

```

I:   target_offset ← sign_extend(offset || 02)
       condition ← GPR[rs] < 0GPRLEN
       GPR[31] ← PC + 8
I+1: if condition then
       PC ← PC + target_offset
       endif

```

Exceptions:

None

Programming Notes:

With the 18-bit signed instruction offset, the conditional branch range is ± 128 KBytes. Use jump and link (JAL) or jump and link register (JALR) instructions for procedure calls to addresses outside this range.

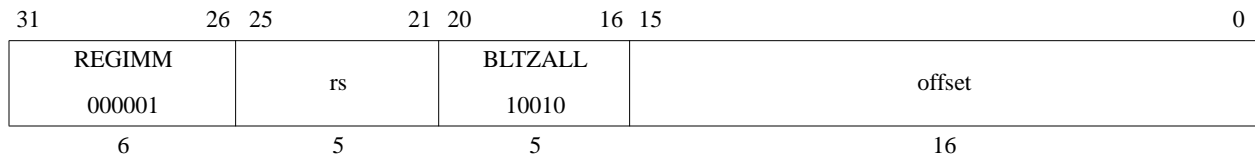

Format: BLTZALL *rs*, *offset*

MIPS32 (MIPS II)

Purpose:

To test a GPR then do a PC-relative conditional procedure call; execute the delay slot only if the branch is taken.

Description: if $rs < 0$ then `procedure_call_likely`

Place the return address link in GPR 31. The return link is the address of the second instruction following the branch, where execution continues after a procedure call.

An 18-bit signed offset (the 16-bit *offset* field shifted left 2 bits) is added to the address of the instruction following the branch (not the branch itself), in the branch delay slot, to form a PC-relative effective target address.

If the contents of GPR *rs* are less than zero (sign bit is 1), branch to the effective target address after the instruction in the delay slot is executed. If the branch is not taken, the instruction in the delay slot is not executed.

Restrictions:

GPR 31 must not be used for the source register *rs*, because such an instruction does not have the same effect when reexecuted. The result of executing such an instruction is UNPREDICTABLE. This restriction permits an exception handler to resume execution by reexecuting the branch when an exception occurs in the branch delay slot.

Processor operation is **UNPREDICTABLE** if a branch, jump, ERET, DERET, or WAIT instruction is placed in the delay slot of a branch or jump.

Operation:

```

I:   target_offset ← sign_extend(offset || 02)
       condition ← GPR[rs] < 0GPRLEN
       GPR[31] ← PC + 8
I+1: if condition then
       PC ← PC + target_offset
       else
       NullifyCurrentInstruction()
       endif

```

Exceptions:

None

Programming Notes:

With the 18-bit signed instruction offset, the conditional branch range is ± 128 KBytes. Use jump and link (JAL) or jump and link register (JALR) instructions for procedure calls to addresses outside this range.

Software is strongly encouraged to avoid the use of the Branch Likely instructions, as they will be removed from a future revision of the MIPS Architecture.

Some implementations always predict the branch will be taken, so there is a significant penalty if the branch is not taken. Software should only use this instruction when there is a very high probability (98% or more) that the branch will be taken. If the branch is not likely to be taken or if the probability of a taken branch is unknown, software is encouraged to use the BLTZAL instruction instead.

Historical Information:

In the MIPS I architecture, this instruction signaled a Reserved Instruction Exception.

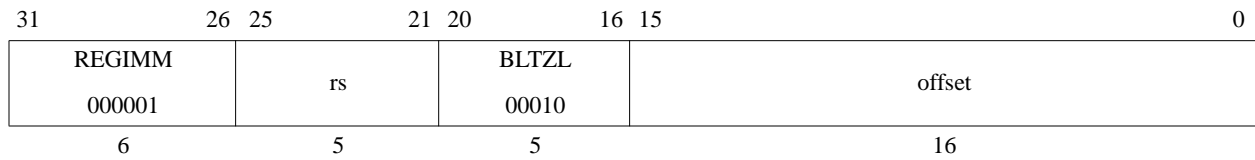

Format: BLTZL *rs*, *offset*

MIPS32 (MIPS II)

Purpose:

To test a GPR then do a PC-relative conditional branch; execute the delay slot only if the branch is taken.

Description: if $rs < 0$ then *branch_likely*

An 18-bit signed offset (the 16-bit *offset* field shifted left 2 bits) is added to the address of the instruction following the branch (not the branch itself), in the branch delay slot, to form a PC-relative effective target address.

If the contents of GPR *rs* are less than zero (sign bit is 1), branch to the effective target address after the instruction in the delay slot is executed. If the branch is not taken, the instruction in the delay slot is not executed.

Restrictions:

Processor operation is **UNPREDICTABLE** if a branch, jump, ERET, DERET, or WAIT instruction is placed in the delay slot of a branch or jump.

Operation:

```

I:    target_offset ← sign_extend(offset || 02)
        condition ← GPR[rs] < 0GPRLEN
I+1:  if condition then
            PC ← PC + target_offset
        else
            NullifyCurrentInstruction()
        endif

```

Exceptions:

None

Programming Notes:

With the 18-bit signed instruction offset, the conditional branch range is ± 128 KBytes. Use jump (J) or jump register (JR) instructions to branch to addresses outside this range.

Software is strongly encouraged to avoid the use of the Branch Likely instructions, as they will be removed from a future revision of the MIPS Architecture.

Some implementations always predict the branch will be taken, so there is a significant penalty if the branch is not taken. Software should only use this instruction when there is a very high probability (98% or more) that the branch will be taken. If the branch is not likely to be taken or if the probability of a taken branch is unknown, software is encouraged to use the BLTZ instruction instead.

Historical Information:

In the MIPS I architecture, this instruction signaled a Reserved Instruction Exception.

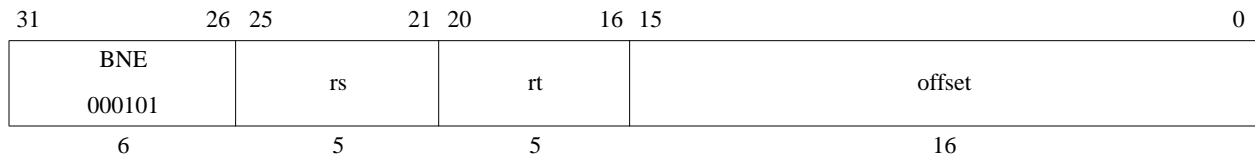
Branch on Not Equal**BNE****Format:** BNE *rs*, *rt*, *offset***MIPS32 (MIPS I)****Purpose:**

To compare GPRs then do a PC-relative conditional branch

Description: if *rs* \neq *rt* then branchAn 18-bit signed offset (the 16-bit *offset* field shifted left 2 bits) is added to the address of the instruction following the branch (not the branch itself), in the branch delay slot, to form a PC-relative effective target address.If the contents of GPR *rs* and GPR *rt* are not equal, branch to the effective target address after the instruction in the delay slot is executed.**Restrictions:**Processor operation is **UNPREDICTABLE** if a branch, jump, ERET, DERET, or WAIT instruction is placed in the delay slot of a branch or jump.**Operation:**

```

I:    target_offset  $\leftarrow$  sign_extend(offset || 02)
        condition  $\leftarrow$  (GPR[rs]  $\neq$  GPR[rt])
I+1:  if condition then
        PC  $\leftarrow$  PC + target_offset
        endif

```

Exceptions:

None

Programming Notes:With the 18-bit signed instruction offset, the conditional branch range is ± 128 KBytes. Use jump (J) or jump register (JR) instructions to branch to addresses outside this range.

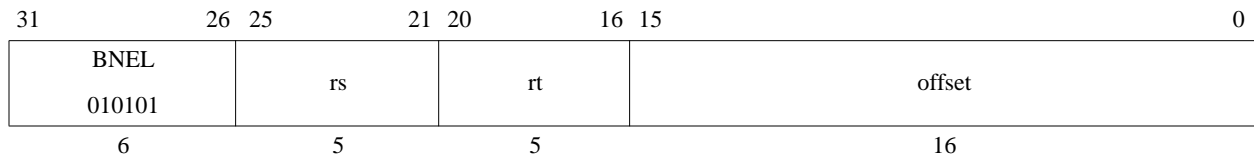

Format: BNEL *rs*, *rt*, *offset*

MIPS32 (MIPS II)

Purpose:

To compare GPRs then do a PC-relative conditional branch; execute the delay slot only if the branch is taken.

Description: if $rs \neq rt$ then *branch_likely*

An 18-bit signed offset (the 16-bit *offset* field shifted left 2 bits) is added to the address of the instruction following the branch (not the branch itself), in the branch delay slot, to form a PC-relative effective target address.

If the contents of GPR *rs* and GPR *rt* are not equal, branch to the effective target address after the instruction in the delay slot is executed. If the branch is not taken, the instruction in the delay slot is not executed.

Restrictions:

Processor operation is **UNPREDICTABLE** if a branch, jump, ERET, DERET, or WAIT instruction is placed in the delay slot of a branch or jump.

Operation:

```

I:    target_offset ← sign_extend(offset || 02)
        condition ← (GPR[rs] ≠ GPR[rt])
I+1:  if condition then
        PC ← PC + target_offset
        else
        NullifyCurrentInstruction()
        endif

```

Exceptions:

None

Programming Notes:

With the 18-bit signed instruction offset, the conditional branch range is ± 128 KBytes. Use jump (J) or jump register (JR) instructions to branch to addresses outside this range.

Software is strongly encouraged to avoid the use of the Branch Likely instructions, as they will be removed from a future revision of the MIPS Architecture.

Some implementations always predict the branch will be taken, so there is a significant penalty if the branch is not taken. Software should only use this instruction when there is a very high probability (98% or more) that the branch will be taken. If the branch is not likely to be taken or if the probability of a taken branch is unknown, software is encouraged to use the BNE instruction instead.

Historical Information:

In the MIPS I architecture, this instruction signaled a Reserved Instruction Exception.

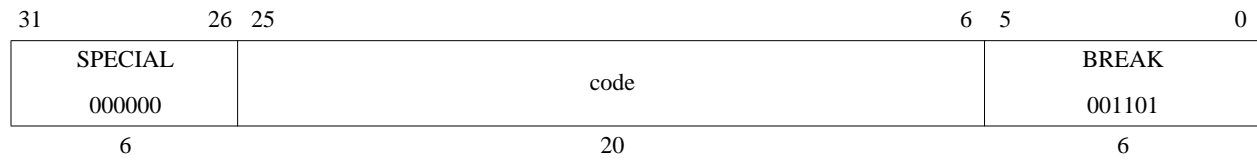
Breakpoint**BREAK****Format:** BREAK**MIPS32 (MIPS I)****Purpose:**

To cause a Breakpoint exception

Description:

A breakpoint exception occurs, immediately and unconditionally transferring control to the exception handler. The *code* field is available for use as software parameters, but is retrieved by the exception handler only by loading the contents of the memory word containing the instruction.

Restrictions:

None

Operation:`SignalException(Breakpoint)`**Exceptions:**

Breakpoint

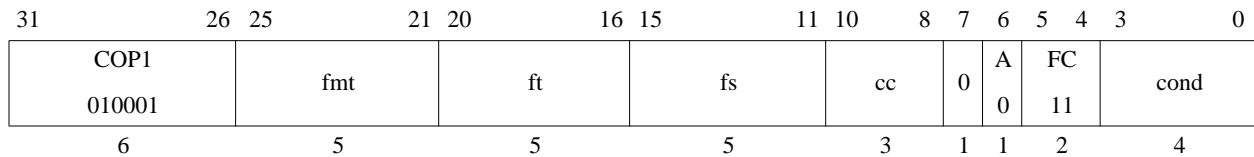

Format: C.cond.S *fs*, *ft* (*cc* = 0 implied)
 C.cond.D *fs*, *ft* (*cc* = 0 implied)
 C.cond.S *cc*, *fs*, *ft*
 C.cond.D *cc*, *fs*, *ft*

MIPS32 (MIPS I)
MIPS32 (MIPS I)
MIPS32 (MIPS IV)
MIPS32 (MIPS IV)

Purpose:

To compare FP values and record the Boolean result in a condition code

Description: $cc \leftarrow fs \text{ compare_cond } ft$

The value in FPR *fs* is compared to the value in FPR *ft*; the values are in format *fmt*. The comparison is exact and neither overflows nor underflows.

If the comparison specified by $cond_{2..1}$ is true for the operand values, the result is true; otherwise, the result is false. If no exception is taken, the result is written into condition code *CC*; true is 1 and false is 0.

If one of the values is an SNaN, or $cond_3$ is set and at least one of the values is a QNaN, an Invalid Operation condition is raised and the Invalid Operation flag is set in the *FCSR*. If the Invalid Operation *Enable* bit is set in the *FCSR*, no result is written and an Invalid Operation exception is taken immediately. Otherwise, the Boolean result is written into condition code *CC*.

There are four mutually exclusive ordering relations for comparing floating point values; one relation is always true and the others are false. The familiar relations are *greater than*, *less than*, and *equal*. In addition, the IEEE floating point standard defines the relation *unordered*, which is true when at least one operand value is NaN; NaN compares unordered with everything, including itself. Comparisons ignore the sign of zero, so +0 equals -0.

The comparison condition is a logical predicate, or equation, of the ordering relations such as *less than or equal*, *equal*, *not less than*, or *unordered or equal*. Compare distinguishes among the 16 comparison predicates. The Boolean result of the instruction is obtained by substituting the Boolean value of each ordering relation for the two FP values in the equation. If the *equal* relation is true, for example, then all four example predicates above yield a true result. If the *unordered* relation is true then only the final predicate, *unordered or equal*, yields a true result.

Logical negation of a compare result allows eight distinct comparisons to test for the 16 predicates as shown in . Each mnemonic tests for both a predicate and its logical negation. For each mnemonic, *compare* tests the truth of the first predicate. When the first predicate is true, the result is true as shown in the “If Predicate Is True” column, and the second predicate must be false, and vice versa. (Note that the False predicate is never true and False/True do not follow the normal pattern.)

The truth of the second predicate is the logical negation of the instruction result. After a compare instruction, test for the truth of the first predicate can be made with the Branch on FP True (BC1T) instruction and the truth of the second can be made with Branch on FP False (BC1F).

Table 3-24 shows another set of eight compare operations, distinguished by a *cond*₃ value of 1 and testing the same 16 conditions. For these additional comparisons, if at least one of the operands is a NaN, including Quiet NaN, then an Invalid Operation condition is raised. If the Invalid Operation condition is enabled in the *FCSR*, an Invalid Operation exception occurs.

Table 3-24 FPU Comparisons Without Special Operand Exceptions

Instruction Cond Mnemonic	Comparison Predicate				Comparison CC Result		Instruction																
	Name of Predicate and Logically Negated Predicate (Abbreviation)	Relation Values				If Predicate Is True	Inv Op Excp. if QNaN ?	Condition Field															
		>	<	=	?			3	2..0														
F	False [this predicate is always False]	F	F	F	F	F	No	0	0														
	True (T)	T	T	T	T																		
UN	Unordered	F	F	F	T	T			No	0	1												
	Ordered (OR)	T	T	T	F	F																	
EQ	Equal	F	F	T	F	T					No	0	2										
	Not Equal (NEQ)	T	T	F	T	F																	
UEQ	Unordered or Equal	F	F	T	T	T							No	0	3								
	Ordered or Greater Than or Less Than (OGL)	T	T	F	F	F																	
OLT	Ordered or Less Than	F	T	F	F	T									No	0	4						
	Unordered or Greater Than or Equal (UGE)	T	F	T	T	F																	
ULT	Unordered or Less Than	F	T	F	T	T											No	0	5				
	Ordered or Greater Than or Equal (OGE)	T	F	T	F	F																	
OLE	Ordered or Less Than or Equal	F	T	T	F	T													No	0	6		
	Unordered or Greater Than (UGT)	T	F	F	T	F																	
ULE	Unordered or Less Than or Equal	F	T	T	T	T															No	0	7
	Ordered or Greater Than (OGT)	T	F	F	F	F																	
Key: ? = unordered, > = greater than, < = less than, = is equal, T = True, F = False																							

Table 3-25 FPU Comparisons With Special Operand Exceptions for QNaNs

Instruction	Comparison Predicate				Comparison CC Result		Instruction			
	Cond Mnemonic	Name of Predicate and Logically Negated Predicate (Abbreviation)	Relation Values				If Predicate Is True	Inv Op Excp If QNaN?	Condition Field	
			>	<	=	?			3	2..0
SF	Signaling False [this predicate always False]	F	F	F	F	F	Yes	1	0	
	Signaling True (ST)	T	T	T	T					
NGLE	Not Greater Than or Less Than or Equal	F	F	F	T	T			1	
	Greater Than or Less Than or Equal (GLE)	T	T	T	F	F				
SEQ	Signaling Equal	F	F	T	F	T			2	
	Signaling Not Equal (SNE)	T	T	F	T	F				
NGL	Not Greater Than or Less Than	F	F	T	T	T			3	
	Greater Than or Less Than (GL)	T	T	F	F	F				
LT	Less Than	F	T	F	F	T			4	
	Not Less Than (NLT)	T	F	T	T	F				
NGE	Not Greater Than or Equal	F	T	F	T	T			5	
	Greater Than or Equal (GE)	T	F	T	F	F				
LE	Less Than or Equal	F	T	T	F	T			6	
	Not Less Than or Equal (NLE)	T	F	F	T	F				
NGT	Not Greater Than	F	T	T	T	T	7			
	Greater Than (GT)	T	F	F	F	F				
Key: ? = unordered, > = greater than, < = less than, = is equal, T = True, F = False										

Restrictions:

The fields *fs* and *ft* must specify FPRs valid for operands of type *fmt*; if they are not valid, the result is **UNPREDICTABLE**.

The operands must be values in format *fmt*; if they are not, the result is **UNPREDICTABLE** and the value of the operand FPRs becomes **UNPREDICTABLE**.

Operation:

```

if SNaN(ValueFPR(fs, fmt)) or SNaN(ValueFPR(ft, fmt)) or
   QNaN(ValueFPR(fs, fmt)) or QNaN(ValueFPR(ft, fmt)) then
  less ← false
  equal ← false
  unordered ← true
  if (SNaN(ValueFPR(fs,fmt)) or SNaN(ValueFPR(ft,fmt))) or
     (cond3 and (QNaN(ValueFPR(fs,fmt)) or QNaN(ValueFPR(ft,fmt)))) then
    SignalException(InvalidOperation)
  endif
else
  less ← ValueFPR(fs, fmt) <fmt ValueFPR(ft, fmt)
  equal ← ValueFPR(fs, fmt) =fmt ValueFPR(ft, fmt)
  unordered ← false
endif
condition ← (cond2 and less) or (cond1 and equal)
             or (cond0 and unordered)
SetFPConditionCode(cc, condition)

```

Exceptions:

Coprocessor Unusable, Reserved Instruction

Floating Point Exceptions:

Unimplemented Operation, Invalid Operation

Programming Notes:

FP computational instructions, including compare, that receive an operand value of Signaling NaN raise the Invalid Operation condition. Comparisons that raise the Invalid Operation condition for Quiet NaNs in addition to SNaNs permit a simpler programming model if NaNs are errors. Using these compares, programs do not need explicit code to check for QNaNs causing the *unordered* relation. Instead, they take an exception and allow the exception handling system to deal with the error when it occurs. For example, consider a comparison in which we want to know if two numbers are equal, but for which *unordered* would be an error.

```
# comparisons using explicit tests for QNaN
  c.eq.d $f2,$f4# check for equal
  nop
  bclt  L2      # it is equal
  c.un.d $f2,$f4# it is not equal,
                # but might be unordered
  bclt  ERROR  # unordered goes off to an error handler
# not-equal-case code here
  ...
# equal-case code here
L2:
# -----
# comparison using comparisons that signal QNaN
  c.seq.d $f2,$f4 # check for equal
  nop
  bclt  L2      # it is equal
  nop
# it is not unordered here
  ...
# not-equal-case code here
  ...
# equal-case code here
```

Historical Information:

The MIPS I architecture defines a single floating point condition code, implemented as the coprocessor 1 condition signal (*Cp1Cond*) and the *C* bit in the FP *Control/Status* register. MIPS I, II, and III architectures must have the *CC* field set to 0, which is implied by the first format in the “Format” section.

The MIPS IV and MIPS32 architectures add seven more *Condition Code* bits to the original condition code 0. FP compare and conditional branch instructions specify the *Condition Code* bit to set or test. Both assembler formats are valid for MIPS IV and MIPS32.

In the MIPS I, II, and III architectures there must be at least one instruction between the compare instruction that sets the condition code and the branch instruction that tests it. Hardware does not detect a violation of this restriction.

Perform Cache Operation

CACHE

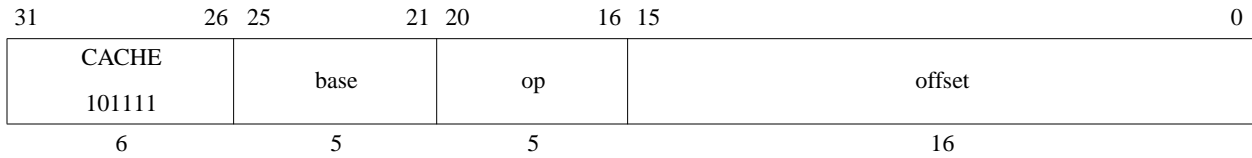

Format: CACHE op, offset(base)

MIPS32

Purpose:

To perform the cache operation specified by op.

Description:

The 16-bit offset is sign-extended and added to the contents of the base register to form an effective address. The effective address is used in one of the following ways based on the operation to be performed and the type of cache as described in the following table.

Table 3-26 Usage of Effective Address

Operation Requires an	Type of Cache	Usage of Effective Address
Address	Virtual	The effective address is used to address the cache. It is implementation dependent whether an address translation is performed on the effective address (with the possibility that a TLB Refill or TLB Invalid exception might occur)
Address	Physical	The effective address is translated by the MMU to a physical address. The physical address is then used to address the cache
Index	N/A	<p>The effective address is translated by the MMU to a physical address. It is implementation dependent whether the effective address or the translated physical address is used to index the cache.</p> <p>Assuming that the total cache size in bytes is CS, the associativity is A, and the number of bytes per tag is BPT, the following calculations give the fields of the address which specify the way and the index:</p> $\text{OffsetBit} \leftarrow \text{Log}_2(\text{BPT})$ $\text{IndexBit} \leftarrow \text{Log}_2(\text{CS} / \text{A})$ $\text{WayBit} \leftarrow \text{IndexBit} + \text{Ceiling}(\text{Log}_2(\text{A}))$ $\text{Way} \leftarrow \text{Addr}_{\text{WayBit}-1..\text{IndexBit}}$ $\text{Index} \leftarrow \text{Addr}_{\text{IndexBit}-1..\text{OffsetBit}}$ <p>For a direct-mapped cache, the Way calculation is ignored and the Index value fully specifies the cache tag. This is shown symbolically in the figure below.</p>

Figure 3-1 Usage of Address Fields to Select Index and Way

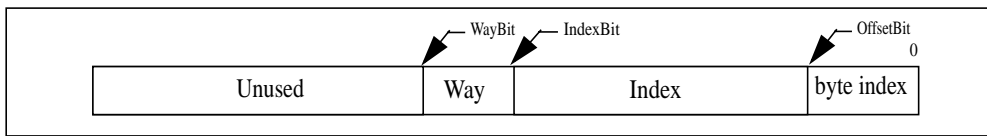

A TLB Refill and TLB Invalid (both with cause code equal TLBL) exception can occur on any operation. For index operations (where the address is used to index the cache but need not match the cache tag) software should use unmapped addresses to avoid TLB exceptions. This instruction never causes TLB Modified exceptions nor TLB Refill exceptions with a cause code of TLBS, nor data Watch exceptions.

A Cache Error exception may occur as a byproduct of some operations performed by this instruction. For example, if a Writeback operation detects a cache or bus error during the processing of the operation, that error is reported via a Cache Error exception. Similarly, a Bus Error Exception may occur if a bus operation invoked by this instruction is terminated in an error.

An Address Error Exception (with cause code equal AdEL) may occur if the effective address references a portion of the kernel address space which would normally result in such an exception. It is implementation dependent whether such an exception does occur.

It is implementation dependent whether a data watch is triggered by a cache instruction whose address matches the Watch register address match conditions.

Bits [17:16] of the instruction specify the cache on which to perform the operation, as follows:

Table 3-27 Encoding of Bits[17:16] of CACHE Instruction

Code	Name	Cache
2#00	I	Primary Instruction
2#01	D	Primary Data or Unified Primary
2#10	T	Tertiary
2#11	S	Secondary

Bits [20:18] of the instruction specify the operation to perform. To provide software with a consistent base of cache operations, certain encodings must be supported on all processors. The remaining encodings are recommended.

Table 3-28 Encoding of Bits [20:18] of the CACHE Instruction

Code	Caches	Name	Effective Address Operand Type	Operation	Compliance
2#000	I	Index Invalidate	Index	<p>Set the state of the cache block at the specified index to invalid.</p> <p>This required encoding may be used by software to invalidate the entire instruction cache by stepping through all valid indices.</p>	Required
	D	Index Writeback Invalidate / Index Invalidate	Index	<p>For a write-back cache: If the state of the cache block at the specified index is valid and dirty, write the block back to the memory address specified by the cache tag. After that operation is completed, set the state of the cache block to invalid. If the block is valid but not dirty, set the state of the block to invalid.</p>	Required
	S, T	Index Writeback Invalidate / Index Invalidate	Index	<p>For a write-through cache: Set the state of the cache block at the specified index to invalid.</p> <p>This required encoding may be used by software to invalidate the entire data cache by stepping through all valid indices. Note that Index Store Tag should be used to initialize the cache at powerup.</p>	Optional
2#001	All	Index Load Tag	Index	<p>Read the tag for the cache block at the specified index into the <i>TagLo</i> and <i>TagHi</i> Coprocessor 0 registers. If the <i>DataLo</i> and <i>DataHi</i> registers are implemented, also read the data corresponding to the byte index into the <i>DataLo</i> and <i>DataHi</i> registers.</p> <p>The granularity and alignment of the data read into the <i>DataLo</i> and <i>DataHi</i> registers is implementation-dependent, but is typically the result of an aligned access to the cache, ignoring the appropriate low-order bits of the byte index.</p>	Recommended

Table 3-28 Encoding of Bits [20:18] of the CACHE Instruction

Code	Caches	Name	Effective Address Operand Type	Operation	Compliance
2#010	All	Index Store Tag	Index	<p>Write the tag for the cache block at the specified index from the <i>TagLo</i> and <i>TagHi</i> Coprocessor 0 registers.</p> <p>This required encoding may be used by software to initialize the entire instruction of data caches by stepping through all valid indices. Doing so requires that the <i>TagLo</i> and <i>TagHi</i> registers associated with the cache be initialized first.</p>	Required
2#011	All	Implementation Dependent	Unspecified	Available for implementation-dependent operation.	Optional
2#100	I, D	Hit Invalidate	Address	<p>If the cache block contains the specified address, set the state of the cache block to invalid.</p> <p>This required encoding may be used by software to invalidate a range of addresses from the instruction cache by stepping through the address range by the line size of the cache.</p>	Required (Instruction Cache Encoding Only), Recommended otherwise
	S, T	Hit Invalidate	Address		Optional
2#101	I	Fill	Address	Fill the cache from the specified address.	Recommended
	D	Hit Writeback Invalidate / Hit Invalidate	Address	For a write-back cache: If the cache block contains the specified address and it is valid and dirty, write the contents back to memory. After that operation is completed, set the state of the cache block to invalid. If the block is valid but not dirty, set the state of the block to invalid.	Required
	S, T	Hit Writeback Invalidate / Hit Invalidate	Address	<p>For a write-through cache: If the cache block contains the specified address, set the state of the cache block to invalid.</p> <p>This required encoding may be used by software to invalidate a range of addresses from the data cache by stepping through the address range by the line size of the cache.</p>	Optional

Table 3-28 Encoding of Bits [20:18] of the CACHE Instruction

Code	Caches	Name	Effective Address Operand Type	Operation	Compliance
2#110	D	Hit Writeback	Address	If the cache block contains the specified address and it is valid and dirty, write the contents back to memory. After the operation is completed, leave the state of the line valid, but clear the dirty state. For a write-through cache, this operation may be treated as a nop.	Recommended
	S, T	Hit Writeback	Address		Optional
2#111	I, D	Fetch and Lock	Address	<p>If the cache does not contain the specified address, fill it from memory, performing a writeback if required, and set the state to valid and locked. If the cache already contains the specified address, set the state to locked. In set-associative or fully-associative caches, the way selected on a fill from memory is implementation dependent.</p> <p>The lock state may be cleared by executing an Index Invalidate, Index Writeback Invalidate, Hit Invalidate, or Hit Writeback Invalidate operation to the locked line, or via an Index Store Tag operation to the line that clears the lock bit. Note that clearing the lock state via Index Store Tag is dependent on the implementation-dependent cache tag and cache line organization, and that Index and Index Writeback Invalidate operations are dependent on cache line organization. Only Hit and Hit Writeback Invalidate operations are generally portable across implementations.</p> <p>It is implementation dependent whether a locked line is displaced as the result of an external invalidate or intervention that hits on the locked line. Software must not depend on the locked line remaining in the cache if an external invalidate or intervention would invalidate the line if it were not locked.</p> <p>It is implementation dependent whether a Fetch and Lock operation affects more than one line. For example, more than one line around the referenced address may be fetched and locked. It is recommended that only the single line containing the referenced address be affected.</p>	Recommended

Restrictions:

The operation of this instruction is **UNDEFINED** for any operation/cache combination that is not implemented.

The operation of this instruction is **UNDEFINED** if the operation requires an address, and that address is uncacheable.

Operation:

```
vAddr ← GPR[base] + sign_extend(offset)
(pAddr, uncached) ← AddressTranslation(vAddr, DataReadReference)
CacheOp(op, vAddr, pAddr)
```

Exceptions:

TLB Refill Exception.

TLB Invalid Exception

Coprocessor Unusable Exception

Address Error Exception

Cache Error Exception

Bus Error Exception

31	26 25	21 20	16 15	11 10	6 5	0
COP1 010001	fmt	0 00000	fs	fd	CEIL.W 001110	
6	5	5	5	5	6	

Format: CEIL.W.S fd, fs
 CEIL.W.D fd, fs

MIPS32 (MIPS II)
MIPS32 (MIPS II)

Purpose:

To convert an FP value to 32-bit fixed point, rounding up

Description: $fd \leftarrow \text{convert_and_round}(fs)$

The value in FPR *fs*, in format *fmt*, is converted to a value in 32-bit word fixed point format and rounding toward $+\infty$ (rounding mode 2). The result is placed in FPR *fd*.

When the source value is Infinity, NaN, or rounds to an integer outside the range -2^{31} to $2^{31}-1$, the result cannot be represented correctly, an IEEE Invalid Operation condition exists, and the Invalid Operation flag is set in the *FCSR*. If the Invalid Operation *Enable* bit is set in the *FCSR*, no result is written to *fd* and an Invalid Operation exception is taken immediately. Otherwise, the default result, $2^{31}-1$, is written to *fd*.

Restrictions:

The fields *fs* and *fd* must specify valid FPRs; *fs* for type *fmt* and *fd* for word fixed point; if they are not valid, the result is **UNPREDICTABLE**.

The operand must be a value in format *fmt*; if it is not, the result is **UNPREDICTABLE** and the value of the operand FPR becomes **UNPREDICTABLE**.

Operation:

`StoreFPR(fd, W, ConvertFmt(ValueFPR(fs, fmt), fmt, W))`

Exceptions:

Coprocessor Unusable, Reserved Instruction

Floating Point Exceptions:

Invalid Operation, Unimplemented Operation, Inexact, Overflow

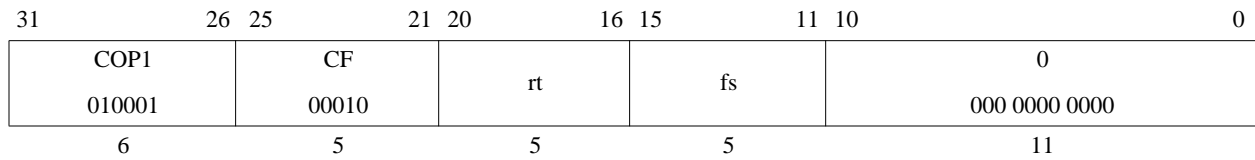

Format: CFC1 *rt*, *fs*

MIPS32 (MIPS I)

Purpose:

To copy a word from an FPU control register to a GPR

Description: $rt \leftarrow FP_Control[fs]$

Copy the 32-bit word from FP (coprocessor 1) control register *fs* into GPR *rt*.

Restrictions:

There are a few control registers defined for the floating point unit. The result is **UNPREDICTABLE** if *fs* specifies a register that does not exist.

Operation:

```

if fs = 0 then
    temp ← FIR
elseif fs = 25 then
    temp ← 024 || FCSR31..25 || FCSR23
elseif fs = 26 then
    temp ← 014 || FCSR17..12 || 05 || FCSR6..2 || 02
elseif fs = 28 then
    temp ← 020 || FCSR11..7 || 04 || FCSR24 || FCSR1..0
elseif fs = 31 then
    temp ← FCSR
else
    temp ← UNPREDICTABLE
endif
GPR[rt] ← temp

```

Exceptions:

Coprocessor Unusable, Reserved Instruction

Historical Information:

For the MIPS I, II and III architectures, the contents of GPR *rt* are **UNPREDICTABLE** for the instruction immediately following CFC1.

MIPS V and MIPS32 introduced the three control registers that access portions of FCSR. These registers were not available in MIPS I, II, III, or IV.

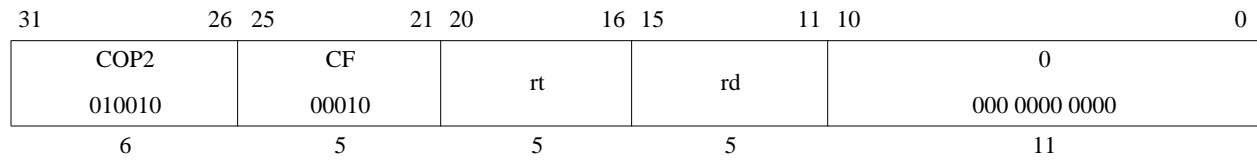
Move Control Word From Coprocessor 2**CFC2****Format:** CFC2 *rt*, *rd***MIPS32****Purpose:**

To copy a word from a Coprocessor 2 control register to a GPR

Description: $rt \leftarrow CCR[2,rd]$ Copy the 32-bit word from Coprocessor 2 control register *rd* into GPR *rt*.**Restrictions:**The result is **UNPREDICTABLE** if *rs* specifies a register that does not exist.**Operation:**

```
temp ← CCR[2,rd]
GPR[rt] ← temp
```

Exceptions:

Coprocessor Unusable, Reserved Instruction

Count Leading Ones in Word

CLO

31	26 25	21 20	16 15	11 10	6 5	0
SPECIAL2 011100	rs	rt	rd	0 00000	CLO 100001	
6	5	5	5	5	6	

Format: CLO rd, rs

MIPS32

Purpose:

To Count the number of leading ones in a word

Description: $rd \leftarrow \text{count_leading_ones } rs$

Bits 31..0 of GPR *rs* are scanned from most significant to least significant bit. The number of leading ones is counted and the result is written to GPR *rd*. If all of bits 31..0 were set in GPR *rs*, the result written to GPR *rd* is 32.

Restrictions:

To be compliant with the MIPS32 and MIPS64 Architecture, software must place the same GPR number in both the *rt* and *rd* fields of the instruction. The operation of the instruction is **UNPREDICTABLE** if the *rt* and *rd* fields of the instruction contain different values.

Operation:

```
temp ← 32
for i in 31 .. 0
  if GPR[rs]i = 0 then
    temp ← 31 - i
    break
  endif
endfor
GPR[rd] ← temp
```

Exceptions:

None

Count Leading Zeros in Word

CLZ

31	26 25	21 20	16 15	11 10	6 5	0
SPECIAL2 011100	rs	rt	rd	0 00000	CLZ 100000	
6	5	5	5	5	6	

Format: CLZ *rd*, *rs*

MIPS32

Purpose

Count the number of leading zeros in a word

Description: $rd \leftarrow \text{count_leading_zeros } rs$

Bits 31..0 of GPR *rs* are scanned from most significant to least significant bit. The number of leading zeros is counted and the result is written to GPR *rd*. If no bits were set in GPR *rs*, the result written to GPR *rd* is 32.

Restrictions:

To be compliant with the MIPS32 and MIPS64 Architecture, software must place the same GPR number in both the *rt* and *rd* fields of the instruction. The operation of the instruction is **UNPREDICTABLE** if the *rt* and *rd* fields of the instruction contain different values.

Operation:

```
temp ← 32
for i in 31 .. 0
    if GPR[rs]i = 1 then
        temp ← 31 - i
        break
    endif
endfor
GPR[rd] ← temp
```

Exceptions:

None

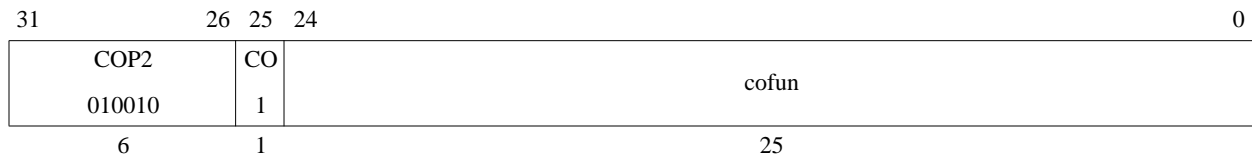

Format: COP2 func

MIPS32

Purpose:

To performance an operation to Coprocessor 2

Description: CoprocessorOperation(2, cofun)

An implementation-dependent operation is performance to Coprocessor 2, with the *cofun* value passed as an argument. The operation may specify and reference internal coprocessor registers, and may change the state of the coprocessor conditions, but does not modify state within the processor. Details of coprocessor operation and internal state are described in the documentation for each Coprocessor 2 implementation.

Restrictions:

Operation:

CoprocessorOperation(2, cofun)

Exceptions:

Coprocessor Unusable

Reserved Instruction

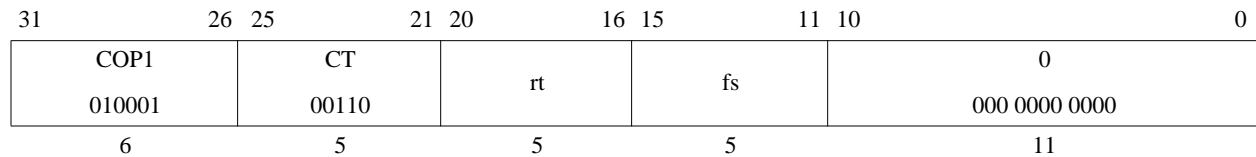
Move Control Word to Floating Point**CTC1****Format:** CTC1 rt, fs**MIPS32 (MIPS I)****Purpose:**

To copy a word from a GPR to an FPU control register

Description: FP_Control[fs] ← rtCopy the low word from GPR *rt* into the FP (coprocessor 1) control register indicated by *fs*.

Writing to the floating point *Control/Status* register, the *FCSR*, causes the appropriate exception if any *Cause* bit and its corresponding *Enable* bit are both set. The register is written before the exception occurs. Writing to *FEXR* to set a cause bit whose enable bit is already set, or writing to *FENR* to set an enable bit whose cause bit is already set causes the appropriate exception. The register is written before the exception occurs.

Restrictions:

There are a few control registers defined for the floating point unit. The result is **UNPREDICTABLE** if *fs* specifies a register that does not exist.

Operation:

```

temp ← GPR[rt]31..0
if fs = 25 then
  if temp31..8 ≠ 024 then
    UNPREDICTABLE
  else
    FCSR ← temp7..1 || FCSR24 || temp0 || FCSR22..0
  endif
elseif fs = 26 then
  if temp22..18 ≠ 0 then
    UNPREDICTABLE
  else
    FCSR ← FCSR31..18 || temp17..12 || FCSR11..7 ||
      temp6..2 || FCSR1..0
  endif
elseif fs = 28 then
  if temp22..18 ≠ 0 then
    UNPREDICTABLE
  else
    FCSR ← FCSR31..25 || temp2 || FCSR23..12 || temp11..7
      || FCSR6..2 || temp1..0
  endif
elseif fs = 31 then
  if temp22..18 ≠ 0 then
    UNPREDICTABLE
  else
    FCSR ← temp
  endif
else
  UNPREDICTABLE
endif

```

Exceptions:

Coprocessor Unusable, Reserved Instruction

Floating Point Exceptions:

Unimplemented Operation, Invalid Operation, Division-by-zero, Inexact, Overflow, Underflow

Historical Information:

For the MIPS I, II and III architectures, the contents of floating point control register *fs* are undefined for the instruction immediately following CTC1.

MIPS V and MIPS32 introduced the three control registers that access portions of FCSR. These registers were not available in MIPS I, II, III, or IV.

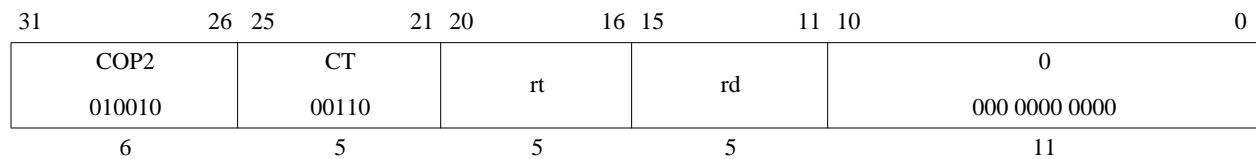
Move Control Word to Coprocessor 2**CTC2****Format:** CTC2 *rt*, *rd***MIPS32****Purpose:**

To copy a word from a GPR to a Coprocessor 2 control register

Description: CCR[2,*rd*] ← *rt*Copy the low word from GPR *rt* into the Coprocessor 2 control register indicated by *rd*.**Restrictions:**The result is **UNPREDICTABLE** if *rd* specifies a register that does not exist.**Operation:**

```
temp ← GPR[rt]
CCR[2,rd] ← temp
```

Exceptions:

Coprocessor Unusable, Reserved Instruction

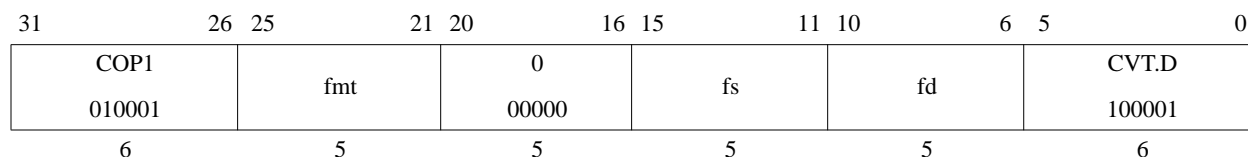

Format: CVT.D.S *fd*, *fs*
 CVT.D.W *fd*, *fs*
 CVT.D.L *fd*, *fs*

MIPS32 (MIPS I)
MIPS32 (MIPS I)
MIPS64 (MIPS III)

Purpose:

To convert an FP or fixed point value to double FP

Description: $fd \leftarrow \text{convert_and_round}(fs)$

The value in FPR *fs*, in format *fmt*, is converted to a value in double floating point format and rounded according to the current rounding mode in *FCSR*. The result is placed in FPR *fd*. If *fmt* is S or W, then the operation is always exact.

Restrictions:

The fields *fs* and *fd* must specify valid FPRs—*fs* for type *fmt* and *fd* for double floating point—if they are not valid, the result is **UNPREDICTABLE**.

The operand must be a value in format *fmt*; if it is not, the result is **UNPREDICTABLE** and the value of the operand FPR becomes **UNPREDICTABLE**.

Operation:

`StoreFPR (fd, D, ConvertFmt(ValueFPR(fs, fmt), fmt, D))`

Exceptions:

Coprocessor Unusable, Reserved Instruction

Floating Point Exceptions:

Invalid Operation, Unimplemented Operation, Inexact

31	26 25	21 20	16 15	11 10	6 5	0
COP1 010001	fmt	0 00000	fs	fd	CVT.S 100000	
6	5	5	5	5	6	

Format: CVT.S.D *fd*, *fs*
 CVT.S.W *fd*, *fs*
 CVT.S.L *fd*, *fs*

MIPS32 (MIPS I)
MIPS32 (MIPS I)
MIPS64 (MIPS III)

Purpose:

To convert an FP or fixed point value to single FP

Description: $fd \leftarrow \text{convert_and_round}(fs)$

The value in FPR *fs*, in format *fmt*, is converted to a value in single floating point format and rounded according to the current rounding mode in *FCSR*. The result is placed in FPR *fd*.

Restrictions:

The fields *fs* and *fd* must specify valid FPRs—*fs* for type *fmt* and *fd* for single floating point. If they are not valid, the result is **UNPREDICTABLE**.

The operand must be a value in format *fmt*; if it is not, the result is **UNPREDICTABLE** and the value of the operand FPR becomes **UNPREDICTABLE**.

Operation:

`StoreFPR(fd, S, ConvertFmt(ValueFPR(fs, fmt), fmt, S))`

Exceptions:

Coprocessor Unusable, Reserved Instruction

Floating Point Exceptions:

Invalid Operation, Unimplemented Operation, Inexact, Overflow, Underflow

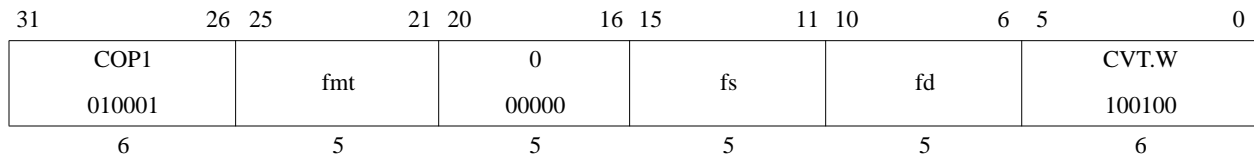

Format: CVT.W.S *fd*, *fs*
 CVT.W.D *fd*, *fs*

MIPS32 (MIPS I)
MIPS32 (MIPS I)

Purpose:

To convert an FP value to 32-bit fixed point

Description: $fd \leftarrow \text{convert_and_round}(fs)$

The value in FPR *fs*, in format *fmt*, is converted to a value in 32-bit word fixed point format and rounded according to the current rounding mode in *FCSR*. The result is placed in FPR *fd*.

When the source value is Infinity, NaN, or rounds to an integer outside the range -2^{31} to $2^{31}-1$, the result cannot be represented correctly, an IEEE Invalid Operation condition exists, and the Invalid Operation flag is set in the *FCSR*. If the Invalid Operation *Enable* bit is set in the *FCSR*, no result is written to *fd* and an Invalid Operation exception is taken immediately. Otherwise, the default result, $2^{31}-1$, is written to *fd*.

Restrictions:

The fields *fs* and *fd* must specify valid FPRs—*fs* for type *fmt* and *fd* for word fixed point—if they are not valid, the result is **UNPREDICTABLE**.

The operand must be a value in format *fmt*; if it is not, the result is **UNPREDICTABLE** and the value of the operand FPR becomes **UNPREDICTABLE**.

Operation:

`StoreFPR(fd, W, ConvertFmt(ValueFPR(fs, fmt), fmt, W))`

Exceptions:

Coprocessor Unusable, Reserved Instruction

Floating Point Exceptions:

Invalid Operation, Unimplemented Operation, Inexact, Overflow

Debug Exception Return**DERET**

31	26	25	24	6	5	0
COP0	CO	0			DERET	
010000	1	000 0000 0000 0000 0000			011111	
6	1	19			6	

Format: DERET

EJTAG

Purpose:

To Return from a debug exception.

Description:

DERET returns from Debug Mode and resumes non-debug execution at the instruction whose address is contained in the *DEPC* register. DERET does not execute the next instruction (i.e. it has no delay slot).

Restrictions:

A DERET placed between an LL and SC instruction does not cause the SC to fail.

If the DEPC register with the return address for the DERET was modified by an MTC0 or a DMTC0 instruction, a CP0 hazard hazard exists that must be removed via software insertion of the appropriate number of SSNOP instructions.

The DERET instruction implements a software barrier for all changes in the CP0 state that could affect the fetch and decode of the instruction at the PC to which the DERET returns, such as changes to the effective ASID, user-mode state, and addressing mode.

This instruction is legal only if the processor is executing in Debug Mode. The operation of the processor is **UNDEFINED** if a DERET is executed in the delay slot of a branch or jump instruction.

Operation:

```
DebugDM ← 0
DebugIEXI ← 0
if IsMIPS16Implemented() then
    PC ← DEPC31..1 || 0
    ISAMode ← 0 || DEPC0
else
    PC ← DEPC
endif
```

Exceptions:

Coprocessor Unusable Exception
Reserved Instruction Exception

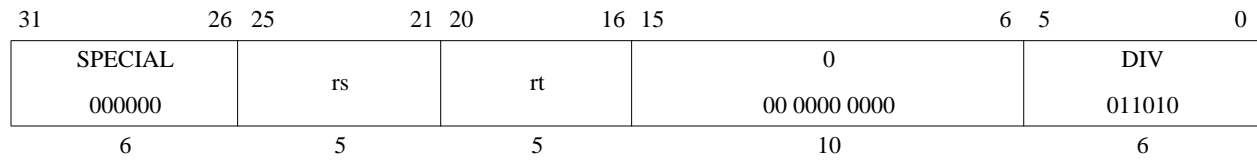
Divide Word**DIV****Format:** DIV *rs*, *rt***MIPS32 (MIPS I)****Purpose:**

To divide a 32-bit signed integers

Description: (LO, HI) \leftarrow *rs* / *rt*

The 32-bit word value in GPR *rs* is divided by the 32-bit value in GPR *rt*, treating both operands as signed values. The 32-bit quotient is placed into special register *LO* and the 32-bit remainder is placed into special register *HI*.

No arithmetic exception occurs under any circumstances.

Restrictions:If the divisor in GPR *rt* is zero, the arithmetic result value is **UNPREDICTABLE**.**Operation:**

```

q ← GPR[rs]31..0 div GPR[rt]31..0
LO ← q
r ← GPR[rs]31..0 mod GPR[rt]31..0
HI ← r

```

Exceptions:

None

Programming Notes:

No arithmetic exception occurs under any circumstances. If divide-by-zero or overflow conditions are detected and some action taken, then the divide instruction is typically followed by additional instructions to check for a zero divisor and/or for overflow. If the divide is asynchronous then the zero-divisor check can execute in parallel with the divide. The action taken on either divide-by-zero or overflow is either a convention within the program itself, or more typically within the system software; one possibility is to take a **BREAK** exception with a *code* field value to signal the problem to the system software.

As an example, the C programming language in a UNIX[®] environment expects division by zero to either terminate the program or execute a program-specified signal handler. C does not expect overflow to cause any exceptional condition. If the C compiler uses a divide instruction, it also emits code to test for a zero divisor and execute a **BREAK** instruction to inform the operating system if a zero is detected.

Where the size of the operands are known, software should place the shorter operand in GPR *rt*. This may reduce the latency of the instruction on those processors which implement data-dependent instruction latencies.

In some processors the integer divide operation may proceed asynchronously and allow other CPU instructions to execute before it is complete. An attempt to read *LO* or *HI* before the results are written interlocks until the results are ready. Asynchronous execution does not affect the program result, but offers an opportunity for performance improvement by scheduling the divide so that other instructions can execute in parallel.

Historical Perspective:

In MIPS 1 through MIPS III, if either of the two instructions preceding the divide is an **MFHI** or **MFLO**, the result of the **MFHI** or **MFLO** is **UNPREDICTABLE**. Reads of the *HI* or *LO* special register must be separated from subsequent instructions that write to them by two or more instructions. This restriction was removed in MIPS IV and MIPS32 and all subsequent levels of the architecture.

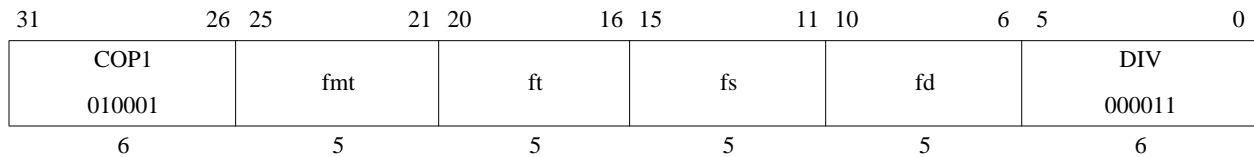

Format: DIV.S *fd*, *fs*, *ft*
 DIV.D *fd*, *fs*, *ft*

MIPS32 (MIPS I)
MIPS32 (MIPS I)

Purpose:

To divide FP values

Description: $fd \leftarrow fs / ft$

The value in FPR *fs* is divided by the value in FPR *ft*. The result is calculated to infinite precision, rounded according to the current rounding mode in *FCSR*, and placed into FPR *fd*. The operands and result are values in format *fmt*.

Restrictions:

The fields *fs*, *ft*, and *fd* must specify FPRs valid for operands of type *fmt*; if they are not valid, the result is **UNPREDICTABLE**.

The operands must be values in format *fmt*; if they are not, the result is **UNPREDICTABLE** and the value of the operand FPRs becomes **UNPREDICTABLE**.

Operation:

StoreFPR (*fd*, *fmt*, ValueFPR(*fs*, *fmt*) / ValueFPR(*ft*, *fmt*))

Exceptions:

Coprocessor Unusable, Reserved Instruction

Floating Point Exceptions:

Inexact, Invalid Operation, Unimplemented Operation, Division-by-zero, Overflow, Underflow

31	26 25	21 20	16 15	6 5	0
SPECIAL 000000	rs	rt	0 00 0000 0000	DIVU 011011	
6	5	5	10	6	

Format: DIVU *rs*, *rt*

MIPS32 (MIPS I)

Purpose:

To divide a 32-bit unsigned integers

Description: $(LO, HI) \leftarrow rs / rt$

The 32-bit word value in GPR *rs* is divided by the 32-bit value in GPR *rt*, treating both operands as unsigned values. The 32-bit quotient is placed into special register *LO* and the 32-bit remainder is placed into special register *HI*.

No arithmetic exception occurs under any circumstances.

Restrictions:

If the divisor in GPR *rt* is zero, the arithmetic result value is undefined.

Operation:

$$\begin{aligned}
 q &\leftarrow (0 \parallel \text{GPR}[rs]_{31..0}) \text{ div } (0 \parallel \text{GPR}[rt]_{31..0}) \\
 r &\leftarrow (0 \parallel \text{GPR}[rs]_{31..0}) \text{ mod } (0 \parallel \text{GPR}[rt]_{31..0}) \\
 LO &\leftarrow \text{sign_extend}(q_{31..0}) \\
 HI &\leftarrow \text{sign_extend}(r_{31..0})
 \end{aligned}$$

Exceptions:

None

Programming Notes:

See “Programming Notes” for the DIV instruction.

Historical Perspective:

In MIPS 1 through MIPS III, if either of the two instructions preceding the divide is an MFHI or MFLO, the result of the MFHI or MFLO is UNPREDICTABLE. Reads of the HI or LO special register must be separated from subsequent instructions that write to them by two or more instructions. This restriction was removed in MIPS IV and MIPS32 and all subsequent levels of the architecture.

Exception Return

ERET

31	26 25 24	6 5	0
COP0 010000	CO 1	0 000 0000 0000 0000 0000	ERET 011000
6	1	19	6

Format: ERET

MIPS32

Purpose:

To return from interrupt, exception, or error trap.

Description:

ERET returns to the interrupted instruction at the completion of interrupt, exception, or error trap processing. ERET does not execute the next instruction (i.e., it has no delay slot).

Restrictions:

The operation of the processor is **UNDEFINED** if an ERET is executed in the delay slot of a branch or jump instruction.

An ERET placed between an LL and SC instruction will always cause the SC to fail.

ERET implements a software barrier for all changes in the CPO state that could affect the fetch and decode of the instruction at the PC to which the ERET returns, such as changes to the effective ASID, user-mode state, and addressing mode.

Operation:

```

if StatusERL = 1 then
    temp ← ErrorEPC
    StatusERL ← 0
else
    temp ← EPC
    StatusEXL ← 0
endif
if IsMIPS16Implemented() then
    PC ← temp31..1 || 0
    ISAMode ← temp0
else
    PC ← temp
endif
LLbit ← 0
    
```

Exceptions:

Coprocessor Unusable Exception

31	26 25	21 20	16 15	11 10	6 5	0
COP1 010001	fmt	0 00000	fs	fd	FLOOR.W 001111	
6	5	5	5	5	6	

Format: FLOOR.W.S fd, fs
 FLOOR.W.D fd, fs

MIPS32 (MIPS II)
MIPS32 (MIPS II)

Purpose:

To convert an FP value to 32-bit fixed point, rounding down

Description: $fd \leftarrow \text{convert_and_round}(fs)$

The value in FPR *fs*, in format *fmt*, is converted to a value in 32-bit word fixed point format and rounded toward $-\infty$ (rounding mode 3). The result is placed in FPR *fd*.

When the source value is Infinity, NaN, or rounds to an integer outside the range -2^{31} to $2^{31}-1$, the result cannot be represented correctly, an IEEE Invalid Operation condition exists, and the Invalid Operation flag is set in the *FCSR*. If the Invalid Operation *Enable* bit is set in the *FCSR*, no result is written to *fd* and an Invalid Operation exception is taken immediately. Otherwise, the default result, $2^{31}-1$, is written to *fd*.

Restrictions:

The fields *fs* and *fd* must specify valid FPRs—*fs* for type *fmt* and *fd* for word fixed point—if they are not valid, the result is **UNPREDICTABLE**.

The operand must be a value in format *fmt*; if it is not, the result is **UNPREDICTABLE** and the value of the operand FPR becomes **UNPREDICTABLE**.

Operation:

`StoreFPR(fd, W, ConvertFmt(ValueFPR(fs, fmt), fmt, W))`

Exceptions:

Coprocessor Unusable, Reserved Instruction

Floating Point Exceptions:

Invalid Operation, Unimplemented Operation, Inexact, Overflow

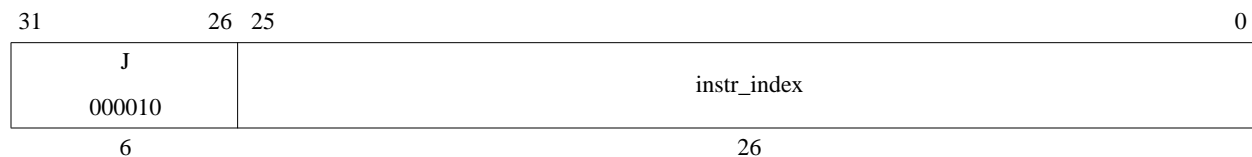

Format: J target

MIPS32 (MIPS I)

Purpose:

To branch within the current 256 MB-aligned region

Description:

This is a PC-region branch (not PC-relative); the effective target address is in the “current” 256 MB-aligned region. The low 28 bits of the target address is the *instr_index* field shifted left 2 bits. The remaining upper bits are the corresponding bits of the address of the instruction in the delay slot (not the branch itself).

Jump to the effective target address. Execute the instruction that follows the jump, in the branch delay slot, before executing the jump itself.

Restrictions:

Processor operation is **UNPREDICTABLE** if a branch, jump, ERET, DERET, or WAIT instruction is placed in the delay slot of a branch or jump.

Operation:

I:
 $I+1:PC \leftarrow PC_{\text{GPRLN}..28} \parallel \text{instr_index} \parallel 0^2$

Exceptions:

None

Programming Notes:

Forming the branch target address by concatenating PC and index bits rather than adding a signed offset to the PC is an advantage if all program code addresses fit into a 256 MB region aligned on a 256 MB boundary. It allows a branch from anywhere in the region to anywhere in the region, an action not allowed by a signed relative offset.

This definition creates the following boundary case: When the jump instruction is in the last word of a 256 MB region, it can branch only to the following 256 MB region containing the branch delay slot.

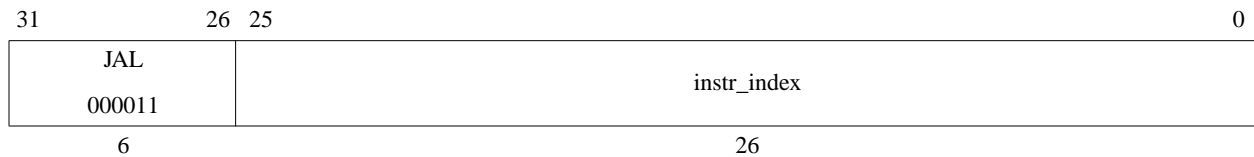

Format: JAL target

MIPS32 (MIPS I)

Purpose:

To execute a procedure call within the current 256 MB-aligned region

Description:

Place the return address link in GPR 31. The return link is the address of the second instruction following the branch, at which location execution continues after a procedure call.

This is a PC-region branch (not PC-relative); the effective target address is in the “current” 256 MB-aligned region. The low 28 bits of the target address is the *instr_index* field shifted left 2 bits. The remaining upper bits are the corresponding bits of the address of the instruction in the delay slot (not the branch itself).

Jump to the effective target address. Execute the instruction that follows the jump, in the branch delay slot, before executing the jump itself.

Restrictions:

Processor operation is **UNPREDICTABLE** if a branch, jump, ERET, DERET, or WAIT instruction is placed in the delay slot of a branch or jump.

Operation:

$$\begin{aligned} \mathbf{I}: \text{GPR}[31] &\leftarrow \text{PC} + 8 \\ \mathbf{I+1:PC} &\leftarrow \text{PC}_{\text{GPRLEN}..28} \parallel \text{instr_index} \parallel 0^2 \end{aligned}$$

Exceptions:

None

Programming Notes:

Forming the branch target address by catenating PC and index bits rather than adding a signed offset to the PC is an advantage if all program code addresses fit into a 256 MB region aligned on a 256 MB boundary. It allows a branch from anywhere in the region to anywhere in the region, an action not allowed by a signed relative offset.

This definition creates the following boundary case: When the branch instruction is in the last word of a 256 MB region, it can branch only to the following 256 MB region containing the branch delay slot.

31	26 25	21 20	16 15	11 10	6 5	0
SPECIAL 000000	rs	0 00000	rd	hint	JALR 001001	
6	5	5	5	5	6	

Format: JALR *rs* (*rd* = 31 implied)
JALR *rd*, *rs*

MIPS32 (MIPS I)
MIPS32 (MIPS I)

Purpose:

To execute a procedure call to an instruction address in a register

Description: $rd \leftarrow \text{return_addr}$, $PC \leftarrow rs$

Place the return address link in GPR *rd*. The return link is the address of the second instruction following the branch, where execution continues after a procedure call.

For processors that do not implement the MIPS16 ASE:

- Jump to the effective target address in GPR *rs*. Execute the instruction that follows the jump, in the branch delay slot, before executing the jump itself.

For processors that do implement the MIPS16 ASE:

- Jump to the effective target address in GPR *rs*. Set the *ISA Mode* bit to the value in GPR *rs* bit 0. Bit 0 of the target address is always zero so that no Address Exceptions occur when bit 0 of the source register is one

At this time the only defined hint field value is 0, which sets default handling of JALR. Future versions of the architecture may define additional hint values.

Restrictions:

Register specifiers *rs* and *rd* must not be equal, because such an instruction does not have the same effect when re-executed. The result of executing such an instruction is undefined. This restriction permits an exception handler to resume execution by reexecuting the branch when an exception occurs in the branch delay slot.

The effective target address in GPR *rs* must be naturally-aligned. For processors that do not implement the MIPS16 ASE, if either of the two least-significant bits are not zero, an Address Error exception occurs when the branch target is subsequently fetched as an instruction. For processors that do implement the MIPS16 ASE, if bit 0 is zero and bit 1 is one, an Address Error exception occurs when the jump target is subsequently fetched as an instruction.

Processor operation is **UNPREDICTABLE** if a branch, jump, ERET, DERET, or WAIT instruction is placed in the delay slot of a branch or jump.

Operation:

```
I: temp ← GPR[rs]
   GPR[rd] ← PC + 8
I+1: if Config1CA = 0 then
    PC ← temp
    else
    PC ← tempGPRLEN-1..1 || 0
    ISAMode ← temp0
endif
```

Exceptions:

None

Programming Notes:

This is the only branch-and-link instruction that can select a register for the return link; all other link instructions use GPR 31. The default register for GPR *rd*, if omitted in the assembly language instruction, is GPR 31.

31	26 25	21 20	11 10	6 5	0
SPECIAL 000000	rs	0 00 0000 0000	hint	JR 001000	
6	5	10	5	6	

Format: JR *rs*

MIPS32 (MIPS I)

Purpose:

To execute a branch to an instruction address in a register

Description: $PC \leftarrow rs$

Jump to the effective target address in GPR *rs*. Execute the instruction following the jump, in the branch delay slot, before jumping.

For processors that implement the MIPS16 ASE, set the *ISA Mode* bit to the value in GPR *rs* bit 0. Bit 0 of the target address is always zero so that no Address Exceptions occur when bit 0 of the source register is one

Restrictions:

The effective target address in GPR *rs* must be naturally-aligned. For processors that do not implement the MIPS16 ASE, if either of the two least-significant bits are not zero, an Address Error exception occurs when the branch target is subsequently fetched as an instruction. For processors that do implement the MIPS16 ASE, if bit 0 is zero and bit 1 is one, an Address Error exception occurs when the jump target is subsequently fetched as an instruction.

At this time the only defined hint field value is 0, which sets default handling of JR. Future versions of the architecture may define additional hint values.

Processor operation is **UNPREDICTABLE** if a branch, jump, ERET, DERET, or WAIT instruction is placed in the delay slot of a branch or jump.

Operation:

```

I: temp ← GPR[rs]
I+1: if Config1CA = 0 then
    PC ← temp
  else
    PC ← tempGPRLEN-1..1 || 0
    ISAMode ← temp0
  endif

```

Exceptions:

None

Programming Notes:

Software should use the value 31 for the *rs* field of the instruction word on return from a JAL, JALR, or BGEZAL, and should use a value other than 31 for remaining uses of JR.

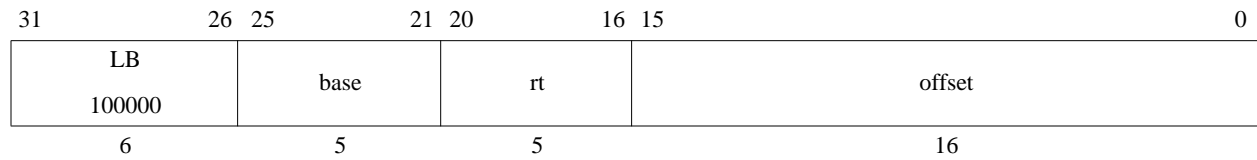

Format: LB *rt*, offset(*base*)

MIPS32 (MIPS I)

Purpose:

To load a byte from memory as a signed value

Description: $rt \leftarrow \text{memory}[\text{base} + \text{offset}]$

The contents of the 8-bit byte at the memory location specified by the effective address are fetched, sign-extended, and placed in GPR *rt*. The 16-bit signed *offset* is added to the contents of GPR *base* to form the effective address.

Restrictions:

None

Operation:

```

vAddr ← sign_extend(offset) + GPR[base]
(pAddr, CCA) ← AddressTranslation (vAddr, DATA, LOAD)
pAddr ← pAddrPSIZE-1..2 || (pAddr1..0 xor ReverseEndian2)
memword ← LoadMemory (CCA, BYTE, pAddr, vAddr, DATA)
byte ← vAddr1..0 xor BigEndianCPU2
GPR[rt] ← sign_extend(memword7+8*byte..8*byte)

```

Exceptions:

TLB Refill, TLB Invalid, Address Error

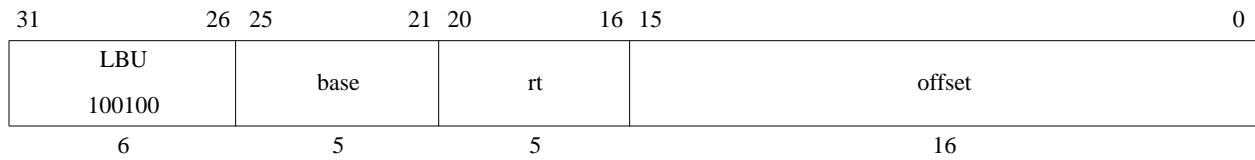
Load Byte Unsigned**LBU****Format:** LBU *rt*, *offset*(*base*)**MIPS32 (MIPS I)****Purpose:**

To load a byte from memory as an unsigned value

Description: $rt \leftarrow \text{memory}[\text{base} + \text{offset}]$

The contents of the 8-bit byte at the memory location specified by the effective address are fetched, zero-extended, and placed in GPR *rt*. The 16-bit signed *offset* is added to the contents of GPR *base* to form the effective address.

Restrictions:

None

Operation:

```

vAddr ← sign_extend(offset) + GPR[base]
(pAddr, CCA) ← AddressTranslation (vAddr, DATA, LOAD)
pAddr ← pAddrPSIZE-1..2 || (pAddr1..0 xor ReverseEndian2)
memword ← LoadMemory (CCA, BYTE, pAddr, vAddr, DATA)
byte ← vAddr1..0 xor BigEndianCPU2
GPR[rt] ← zero_extend(memword7+8*byte..8*byte)

```

Exceptions:

TLB Refill, TLB Invalid, Address Error

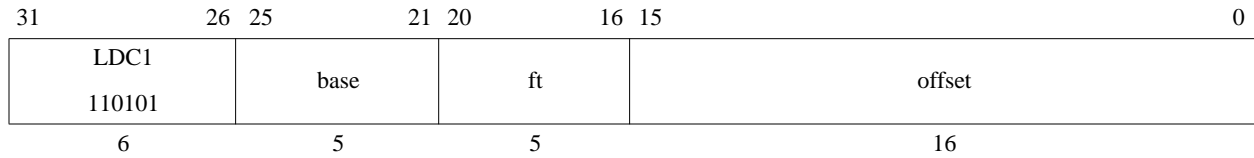

Format: LDC1 ft, offset(base)

MIPS32 (MIPS II)

Purpose:

To load a doubleword from memory to an FPR

Description: $ft \leftarrow \text{memory}[\text{base}+\text{offset}]$

The contents of the 64-bit doubleword at the memory location specified by the aligned effective address are fetched and placed in FPR *ft*. The 16-bit signed *offset* is added to the contents of GPR *base* to form the effective address.

Restrictions:

An Address Error exception occurs if $\text{EffectiveAddress}_{2..0} \neq 0$ (not doubleword-aligned).

Operation:

```

vAddr ← sign_extend(offset) + GPR[base]
if vAddr2..0 ≠ 03 then
    SignalException(AddressError)
endif
(pAddr, CCA) ← AddressTranslation (vAddr, DATA, LOAD)
memdoubleword ← LoadMemory(CCA, DOUBLEWORD, pAddr, vAddr, DATA)
StoreFPR(ft, UNINTERPRETED_DOUBLEWORD, memdoubleword)
    
```

Exceptions:

Coprocessor Unusable, Reserved Instruction, TLB Refill, TLB Invalid, Address Error

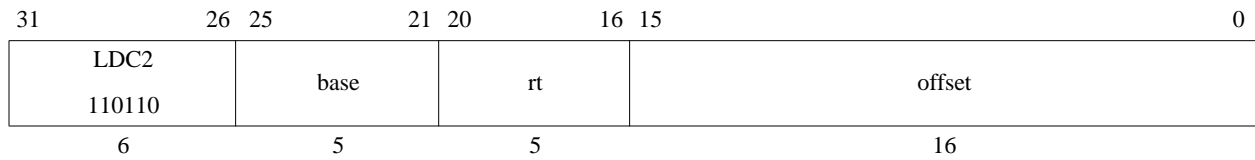

Format: LDC2 *rt*, *offset*(*base*)

MIPS32

Purpose:

To load a doubleword from memory to a Coprocessor 2 register

Description: $rt \leftarrow \text{memory}[\text{base} + \text{offset}]$

The contents of the 64-bit doubleword at the memory location specified by the aligned effective address are fetched and placed in Coprocessor 2 register *rt*. The 16-bit signed *offset* is added to the contents of GPR *base* to form the effective address.

Restrictions:

An Address Error exception occurs if $\text{EffectiveAddress}_{2..0} \neq 0$ (not doubleword-aligned).

Operation:

```
vAddr ← sign_extend(offset) + GPR[base]
if vAddr2..0 ≠ 03 then SignalException(AddressError) endif
(pAddr, CCA) ← AddressTranslation(vAddr, DATA, LOAD)
memdoubleword ← LoadMemory(CCA, DOUBLEWORD, pAddr, vAddr, DATA)
CPR[2,rt,0] ← memdoubleword
```

Exceptions:

Coprocessor Unusable, Reserved Instruction, TLB Refill, TLB Invalid, Address Error

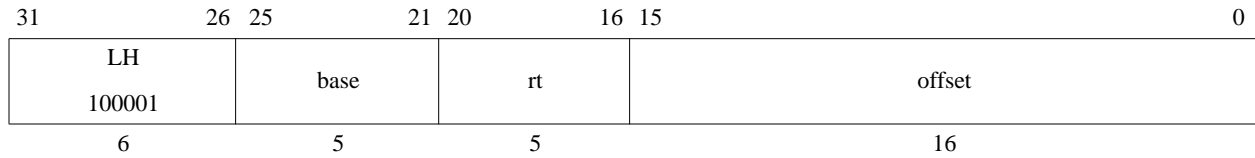

Format: LH *rt*, *offset*(*base*)

MIPS32 (MIPS I)

Purpose:

To load a halfword from memory as a signed value

Description: $rt \leftarrow \text{memory}[\text{base} + \text{offset}]$

The contents of the 16-bit halfword at the memory location specified by the aligned effective address are fetched, sign-extended, and placed in GPR *rt*. The 16-bit signed *offset* is added to the contents of GPR *base* to form the effective address.

Restrictions:

The effective address must be naturally-aligned. If the least-significant bit of the address is non-zero, an Address Error exception occurs.

Operation:

```

vAddr ← sign_extend(offset) + GPR[base]
if vAddr0 ≠ 0 then
    SignalException(AddressError)
endif
(pAddr, CCA) ← AddressTranslation (vAddr, DATA, LOAD)
pAddr ← pAddrPSIZE-1..2 || (pAddr1..0 xor (ReverseEndian || 0))
memword ← LoadMemory (CCA, HALFWORD, pAddr, vAddr, DATA)
byte ← vAddr1..0 xor (BigEndianCPU || 0)
GPR[rt] ← sign_extend(memword15+8*byte..8*byte)

```

Exceptions:

TLB Refill, TLB Invalid, Bus Error, Address Error

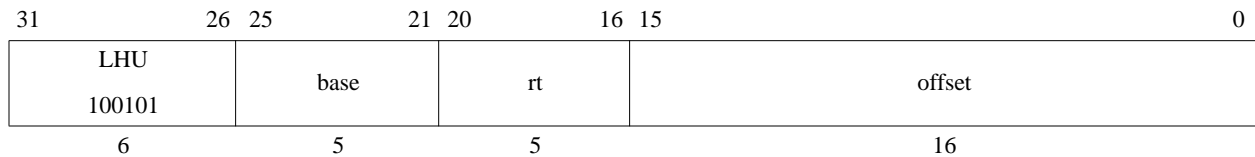

Format: LHU *rt*, *offset*(*base*)

MIPS32 (MIPS I)

Purpose:

To load a halfword from memory as an unsigned value

Description: $rt \leftarrow \text{memory}[\text{base} + \text{offset}]$

The contents of the 16-bit halfword at the memory location specified by the aligned effective address are fetched, zero-extended, and placed in GPR *rt*. The 16-bit signed *offset* is added to the contents of GPR *base* to form the effective address.

Restrictions:

The effective address must be naturally-aligned. If the least-significant bit of the address is non-zero, an Address Error exception occurs.

Operation:

```

vAddr ← sign_extend(offset) + GPR[base]
if vAddr0 ≠ 0 then
    SignalException(AddressError)
endif
(pAddr, CCA) ← AddressTranslation (vAddr, DATA, LOAD)
pAddr ← pAddrPSIZE-1..2 || (pAddr1..0 xor (ReverseEndian || 0))
memword ← LoadMemory (CCA, HALFWORD, pAddr, vAddr, DATA)
byte ← vAddr1..0 xor (BigEndianCPU || 0)
GPR[rt] ← zero_extend(memword15+8*byte..8*byte)

```

Exceptions:

TLB Refill, TLB Invalid, Address Error

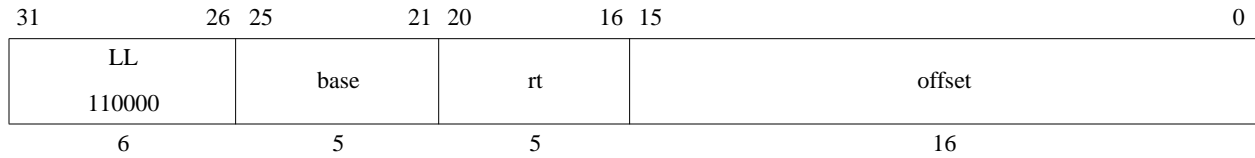

Format: LL *rt*, *offset*(*base*)

MIPS32 (MIPS II)

Purpose:

To load a word from memory for an atomic read-modify-write

Description: $rt \leftarrow \text{memory}[\text{base} + \text{offset}]$

The LL and SC instructions provide the primitives to implement atomic read-modify-write (RMW) operations for cached memory locations.

The 16-bit signed *offset* is added to the contents of GPR *base* to form an effective address. The contents of the 32-bit word at the memory location specified by the aligned effective address are fetched, sign-extended to the GPR register length if necessary, and written into GPR *rt*.

This begins a RMW sequence on the current processor. There can be only one active RMW sequence per processor.

When an LL is executed it starts an active RMW sequence replacing any other sequence that was active.

The RMW sequence is completed by a subsequent SC instruction that either completes the RMW sequence atomically and succeeds, or does not and fails.

Executing LL on one processor does not cause an action that, by itself, causes an SC for the same block to fail on another processor.

An execution of LL does not have to be followed by execution of SC; a program is free to abandon the RMW sequence without attempting a write.

Restrictions:

The addressed location must be cached; if it is not, the result is undefined.

The effective address must be naturally-aligned. If either of the 2 least-significant bits of the effective address is non-zero, an Address Error exception occurs.

Operation:

```

vAddr ← sign_extend(offset) + GPR[base]
if vAddr1..0 ≠ 02 then
    SignalException(AddressError)
endif
(pAddr, CCA) ← AddressTranslation (vAddr, DATA, LOAD)
memword ← LoadMemory (CCA, WORD, pAddr, vAddr, DATA)
GPR[rt] ← memword
LLbit ← 1

```

Exceptions:

TLB Refill, TLB Invalid, Address Error, Reserved Instruction

Programming Notes:

There is no Load Linked Word Unsigned operation corresponding to Load Word Unsigned.

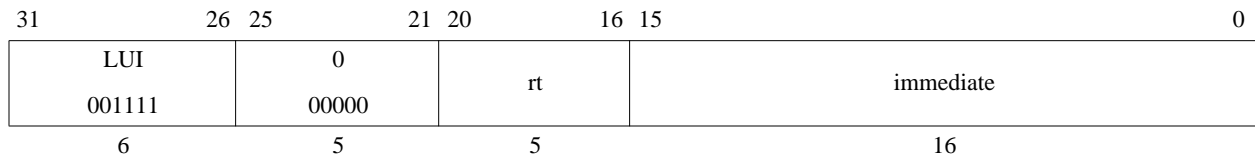
Load Upper Immediate**LUI****Format:** LUI *rt*, *immediate***MIPS32 (MIPS I)****Purpose:**

To load a constant into the upper half of a word

Description: $rt \leftarrow \text{immediate} \parallel 0^{16}$ The 16-bit *immediate* is shifted left 16 bits and concatenated with 16 bits of low-order zeros. The 32-bit result is placed into GPR *rt*.**Restrictions:**

None

Operation: $\text{GPR}[rt] \leftarrow \text{immediate} \parallel 0^{16}$ **Exceptions:**

None

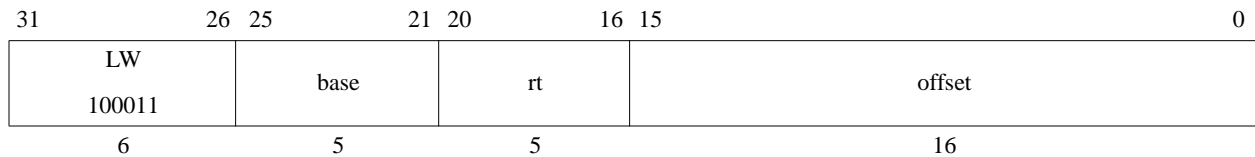

Format: LW *rt*, *offset*(*base*)

MIPS32 (MIPS I)

Purpose:

To load a word from memory as a signed value

Description: $rt \leftarrow \text{memory}[\text{base} + \text{offset}]$

The contents of the 32-bit word at the memory location specified by the aligned effective address are fetched, sign-extended to the GPR register length if necessary, and placed in GPR *rt*. The 16-bit signed *offset* is added to the contents of GPR *base* to form the effective address.

Restrictions:

The effective address must be naturally-aligned. If either of the 2 least-significant bits of the address is non-zero, an Address Error exception occurs.

Operation:

```
vAddr ← sign_extend(offset) + GPR[base]
if vAddr1..0 ≠ 02 then
    SignalException(AddressError)
endif
(pAddr, CCA) ← AddressTranslation (vAddr, DATA, LOAD)
memword ← LoadMemory (CCA, WORD, pAddr, vAddr, DATA)
GPR[rt] ← memword
```

Exceptions:

TLB Refill, TLB Invalid, Bus Error, Address Error

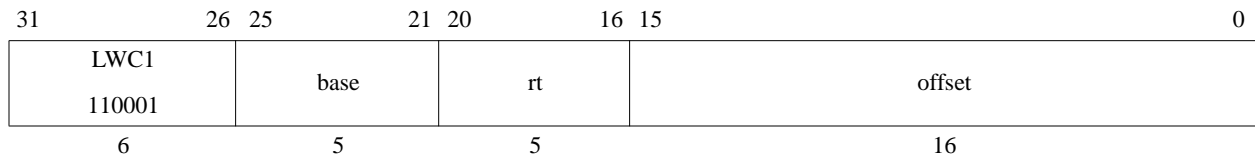

Format: LWC1 *ft*, *offset*(*base*)

MIPS32 (MIPS I)

Purpose:

To load a word from memory to an FPR

Description: $ft \leftarrow \text{memory}[\text{base} + \text{offset}]$

The contents of the 32-bit word at the memory location specified by the aligned effective address are fetched and placed into the low word of coprocessor 1 general register *ft*. The 16-bit signed *offset* is added to the contents of GPR *base* to form the effective address.

Restrictions:

An Address Error exception occurs if $\text{EffectiveAddress}_{1..0} \neq 0$ (not word-aligned).

Operation:

```

/* mem is aligned 64 bits from memory. Pick out correct bytes. */
vAddr ← sign_extend(offset) + GPR[base]
if vAddr1..0 ≠ 02 then
    SignalException(AddressError)
endif
(pAddr, CCA) ← AddressTranslation (vAddr, DATA, LOAD)

memword ← LoadMemory(CCA, WORD, pAddr, vAddr, DATA)

StoreFPR(ft, UNINTERPRETED_WORD,
          memword)

```

Exceptions:

TLB Refill, TLB Invalid, Address Error, Reserved Instruction, Coprocessor Unusable

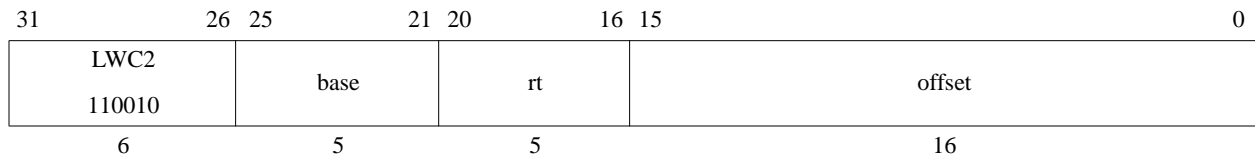

Format: LWC2 *rt*, *offset*(*base*)

MIPS32 (MIPS I)

Purpose:

To load a word from memory to a COP2 register

Description: $rt \leftarrow \text{memory}[\text{base} + \text{offset}]$

The contents of the 32-bit word at the memory location specified by the aligned effective address are fetched and placed into the low word of COP2 (Coprocessor 2) general register *rt*. The 16-bit signed *offset* is added to the contents of GPR *base* to form the effective address.

Restrictions:

An Address Error exception occurs if $\text{EffectiveAddress}_{1..0} \neq 0$ (not word-aligned).

Operation:

```

vAddr ← sign_extend(offset) + GPR[base]
if vAddr12..0 ≠ 02 then
    SignalException(AddressError)
endif
(pAddr, CCA) ← AddressTranslation (vAddr, DATA, LOAD)

memword ← LoadMemory(CCA, DOUBLEWORD, pAddr, vAddr, DATA)

CPR[2,rt,0] ← memword

```

Exceptions:

TLB Refill, TLB Invalid, Address Error, Reserved Instruction, Coprocessor Unusable

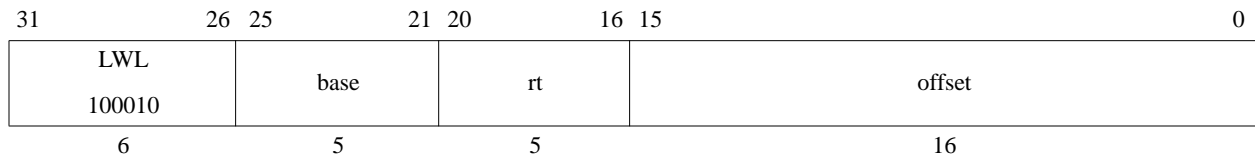

Format: LWL *rt*, *offset*(*base*)

MIPS32 (MIPS I)

Purpose:

To load the most-significant part of a word as a signed value from an unaligned memory address

Description: $rt \leftarrow rt \text{ MERGE } \text{memory}[\text{base}+\text{offset}]$

The 16-bit signed *offset* is added to the contents of GPR *base* to form an effective address (*EffAddr*). *EffAddr* is the address of the most-significant of 4 consecutive bytes forming a word (*W*) in memory starting at an arbitrary byte boundary.

The most-significant 1 to 4 bytes of *W* is in the aligned word containing the *EffAddr*. This part of *W* is loaded into the most-significant (left) part of the word in GPR *rt*. The remaining least-significant part of the word in GPR *rt* is unchanged.

The figure below illustrates this operation using big-endian byte ordering for 32-bit and 64-bit registers. The 4 consecutive bytes in 2..5 form an unaligned word starting at location 2. A part of *W*, 2 bytes, is in the aligned word containing the most-significant byte at 2. First, LWL loads these 2 bytes into the left part of the destination register word and leaves the right part of the destination word unchanged. Next, the complementary LWR loads the remainder of the unaligned word

Figure 3-2 Unaligned Word Load Using LWL and LWR

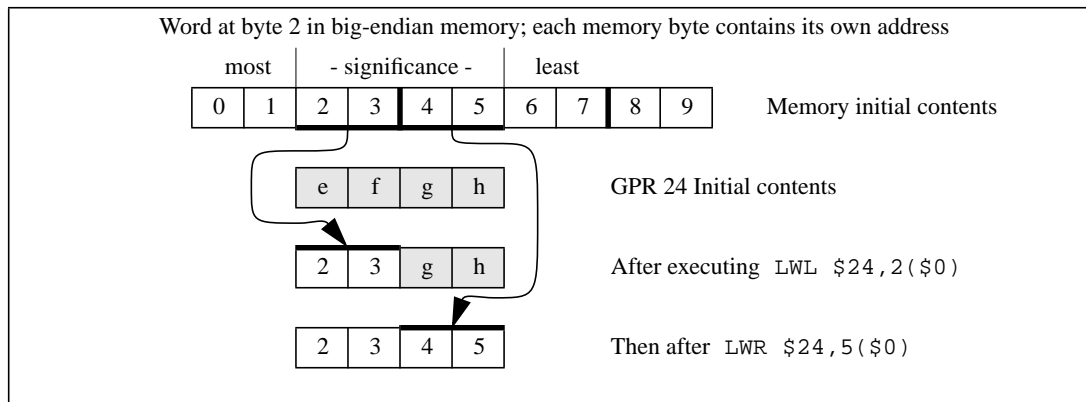

The bytes loaded from memory to the destination register depend on both the offset of the effective address within an aligned word, that is, the low 2 bits of the address ($vAddr_{1..0}$), and the current byte-ordering mode of the processor (big- or little-endian). The figure below shows the bytes loaded for every combination of offset and byte ordering.

Figure 3-3 Bytes Loaded by LWL Instruction

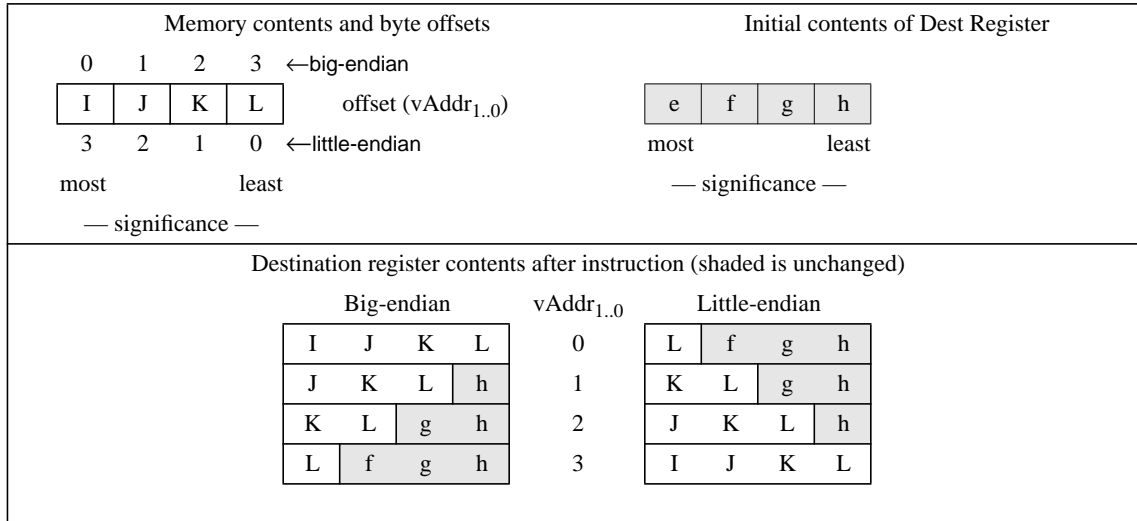

Restrictions:

None

Operation:

```

vAddr ← sign_extend(offset) + GPR[base]
(pAddr, CCA) ← AddressTranslation (vAddr, DATA, LOAD)
pAddr ← pAddrPSIZE-1..2 || (pAddr1..0 xor ReverseEndian2)
if BigEndianMem = 0 then
    pAddr ← pAddrPSIZE-1..2 || 02
endif
byte ← vAddr1..0 xor BigEndianCPU2
memword ← LoadMemory (CCA, byte, pAddr, vAddr, DATA)
temp ← memword7+8*byte..0 || GPR[rt]23-8*byte..0
GPR[rt] ← temp

```

Exceptions:

None

TLB Refill, TLB Invalid, Bus Error, Address Error

Programming Notes:

The architecture provides no direct support for treating unaligned words as unsigned values, that is, zeroing bits 63..32 of the destination register when bit 31 is loaded.

Historical Information

In the MIPS I architecture, the LWL and LWR instructions were exceptions to the load-delay scheduling restriction. A LWL or LWR instruction which was immediately followed by another LWL or LWR instruction, and used the same destination register would correctly merge the 1 to 4 loaded bytes with the data loaded by the previous instruction. All such restrictions were removed from the architecture in MIPS II.

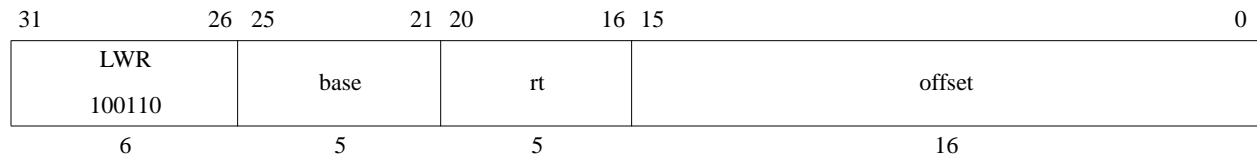

Format: LWR *rt*, *offset*(*base*)

MIPS32 (MIPS I)

Purpose:

To load the least-significant part of a word from an unaligned memory address as a signed value

Description: $rt \leftarrow rt \text{ MERGE } \text{memory}[\text{base}+\text{offset}]$

The 16-bit signed *offset* is added to the contents of GPR *base* to form an effective address (*EffAddr*). *EffAddr* is the address of the least-significant of 4 consecutive bytes forming a word (*W*) in memory starting at an arbitrary byte boundary.

A part of *W*, the least-significant 1 to 4 bytes, is in the aligned word containing *EffAddr*. This part of *W* is loaded into the least-significant (right) part of the word in GPR *rt*. The remaining most-significant part of the word in GPR *rt* is unchanged.

Executing both LWR and LWL, in either order, delivers a sign-extended word value in the destination register.

The figure below illustrates this operation using big-endian byte ordering for 32-bit and 64-bit registers. The 4 consecutive bytes in 2..5 form an unaligned word starting at location 2. A part of *W*, 2 bytes, is in the aligned word containing the least-significant byte at 5. First, LWR loads these 2 bytes into the right part of the destination register. Next, the complementary LWL loads the remainder of the unaligned word.

Figure 3-4 Unaligned Word Load Using LWL and LWR

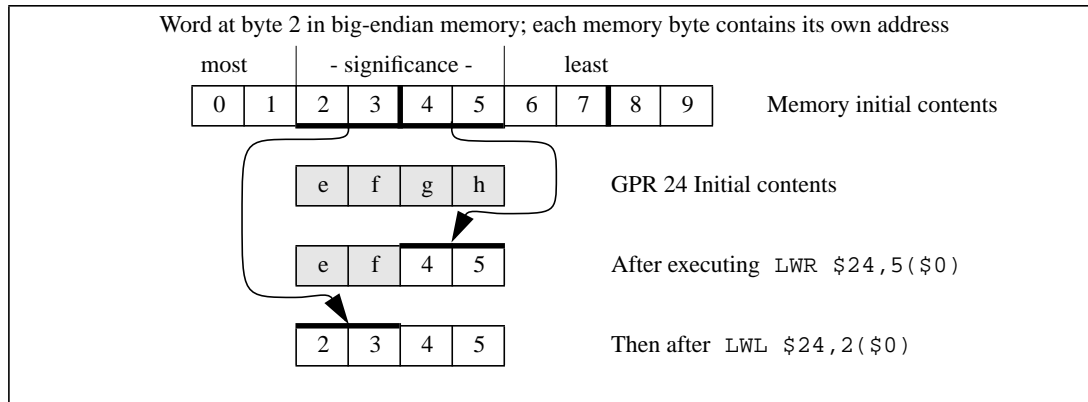

The bytes loaded from memory to the destination register depend on both the offset of the effective address within an aligned word, that is, the low 2 bits of the address ($vAddr_{1,0}$), and the current byte-ordering mode of the processor (big- or little-endian). The figure below shows the bytes loaded for every combination of offset and byte ordering.

Figure 3-5 Bytes Loaded by LWR Instruction

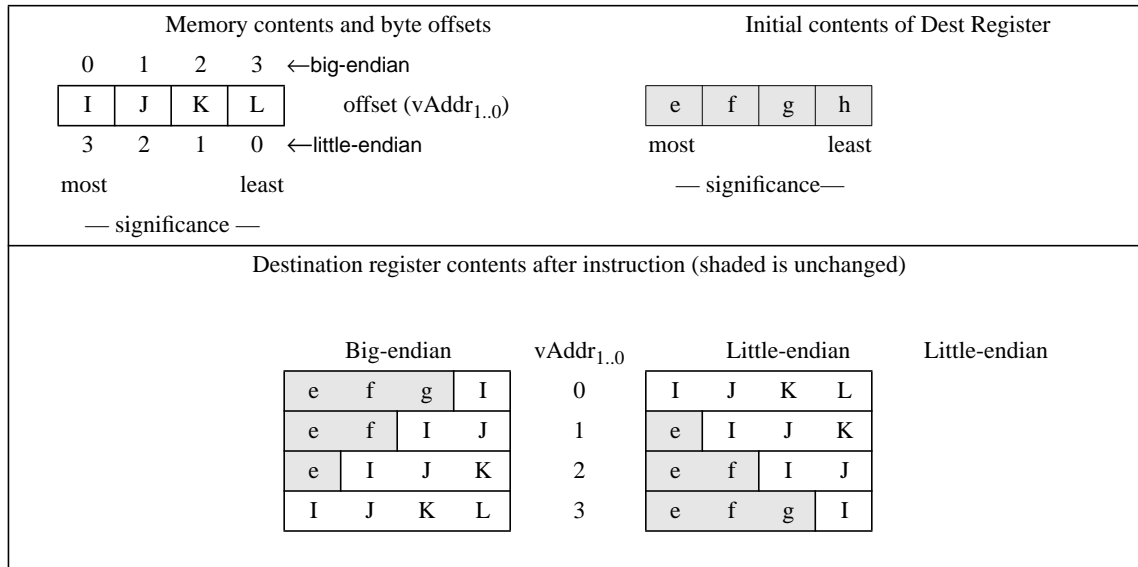

Restrictions:

None

Operation:

```

vAddr ← sign_extend(offset) + GPR[base]
(pAddr, CCA) ← AddressTranslation (vAddr, DATA, LOAD)
pAddr ← pAddrPSIZE-1..2 || (pAddr1..0 xor ReverseEndian2)
if BigEndianMem = 0 then
    pAddr ← pAddrPSIZE-1..2 || 02
endif
byte ← vAddr1..0 xor BigEndianCPU2
memword ← LoadMemory (CCA, byte, pAddr, vAddr, DATA)
temp ← memword31..32-8*byte || GPR[rt]31-8*byte..0
GPR[rt] ← temp

```

Exceptions:

TLB Refill, TLB Invalid, Bus Error, Address Error

Programming Notes:

The architecture provides no direct support for treating unaligned words as unsigned values, that is, zeroing bits 63..32 of the destination register when bit 31 is loaded.

Historical Information

In the MIPS I architecture, the LWL and LWR instructions were exceptions to the load-delay scheduling restriction. A LWL or LWR instruction which was immediately followed by another LWL or LWR instruction, and used the same destination register would correctly merge the 1 to 4 loaded bytes with the data loaded by the previous instruction. All such restrictions were removed from the architecture in MIPS II.

31	26 25	21 20	16 15	11 10	6 5	0
SPECIAL2 011100	rs	rt	0 0000	0 00000	MADD 000000	
6	5	5	5	5	6	

Format: MADD *rs*, *rt*

MIPS32

Purpose:

To multiply two words and add the result to Hi, Lo

Description: $(LO, HI) \leftarrow (rs \times rt) + (LO, HI)$

The 32-bit word value in GPR *rs* is multiplied by the 32-bit word value in GPR *rt*, treating both operands as signed values, to produce a 64-bit result. The product is added to the 64-bit concatenated values of *HI* and *LO*. The most significant 32 bits of the result are written into *HI* and the least significant 32 bits are written into *LO*. No arithmetic exception occurs under any circumstances.

Restrictions:

None

This instruction does not provide the capability of writing directly to a target GPR.

Operation:

```
temp ← (HI || LO) + (GPR[rs] * GPR[rt])
HI ← temp63..32
LO ← temp31..0
```

Exceptions:

None

Programming Notes:

Where the size of the operands are known, software should place the shorter operand in GPR *rt*. This may reduce the latency of the instruction on those processors which implement data-dependent instruction latencies.

31	26 25	21 20	16 15	11 10	6 5	0
SPECIAL2 011100	rs	rt	0 00000	0 00000	MADDU 000001	
6	5	5	5	5	6	

Format: MADDU *rs*, *rt*

MIPS32

Purpose:

To multiply two unsigned words and add the result to Hi, Lo.

Description: $(LO, HI) \leftarrow (rs \times rt) + (LO, HI)$

The 32-bit word value in GPR *rs* is multiplied by the 32-bit word value in GPR *rt*, treating both operands as unsigned values, to produce a 64-bit result. The product is added to the 64-bit concatenated values of *HI* and *LO*. The most significant 32 bits of the result are written into *HI* and the least significant 32 bits are written into *LO*. No arithmetic exception occurs under any circumstances.

Restrictions:

None

This instruction does not provide the capability of writing directly to a target GPR.

Operation:

```
temp ← (HI || LO) + (GPR[rs] * GPR[rt])
HI ← temp63..32
LO ← temp31..0
```

Exceptions:

None

Programming Notes:

Where the size of the operands are known, software should place the shorter operand in GPR *rt*. This may reduce the latency of the instruction on those processors which implement data-dependent instruction latencies.

Move from Coprocessor 0**MFC0**

31	26 25	21 20	16 15	11 10	3 2 0
COP0 010000	MF 00000	rt	rd	0 00000000	sel
6	5	5	5	8	3

Format: MFC0 *rt*, *rd***MIPS32****Purpose:**

To move the contents of a coprocessor 0 register to a general register.

Description: $rt \leftarrow CPR[0,rd,sel]$

The contents of the coprocessor 0 register specified by the combination of *rd* and *sel* are loaded into general register *rt*. Note that not all coprocessor 0 registers support the *sel* field. In those instances, the *sel* field must be zero.

Restrictions:

The results are **UNDEFINED** if coprocessor 0 does not contain a register as specified by *rd* and *sel*.

Operation:

```
data ← CPR[0,rd,sel]
GPR[rt] ← data
```

Exceptions:

Coprocessor Unusable

Reserved Instruction

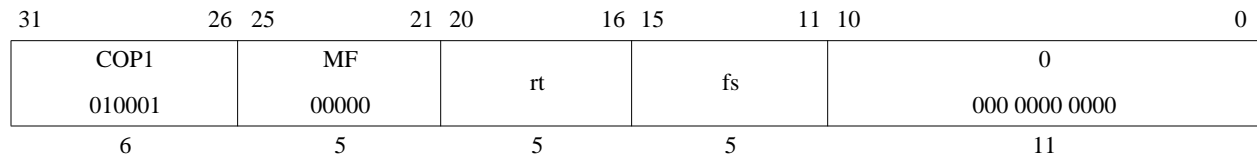

Format: MFC1 *rt*, *fs*

MIPS32 (MIPS I)

Purpose:

To copy a word from an FPU (CP1) general register to a GPR

Description: $rt \leftarrow fs$

The contents of FPR *fs* are loaded into general register *rt*.

Restrictions:

Operation:

```
data ← ValueFPR(fs, UNINTERPRETED_WORD)
GPR[rt] ← data
```

Exceptions:

Coprocessor Unusable, Reserved Instruction

Historical Information:

For MIPS I, MIPS II, and MIPS III the contents of GPR *rt* are undefined for the instruction immediately following MFC1.

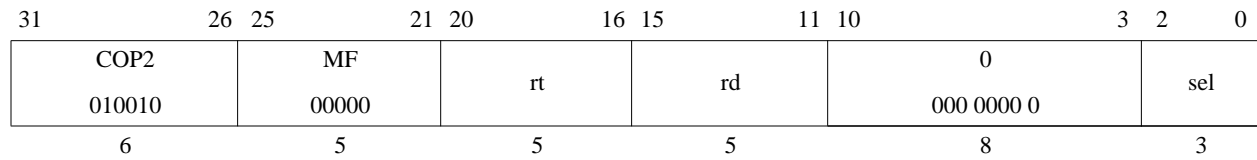
Move Word From Coprocessor 2**MFC2**

Format: MFC2 *rt*, *rd*
MFC2, *rt*, *rd*, *sel*

MIPS32
MIPS32

Purpose:

To copy a word from a COP2 general register to a GPR

Description: $rt \leftarrow rd$

The contents of GPR *rt* are and placed into the coprocessor 2 register specified by the *rd* and *sel* fields. Note that not all coprocessor 2 registers may support the *sel* field. In those instances, the *sel* field must be zero.

Restrictions:

The results are **UNPREDICTABLE** is coprocessor 2 does not contain a register as specified by *rd* and *sel*.

Operation:

```
data ← CPR[2,rd,sel]
GPR[rt] ← data
```

Exceptions:

Coprocessor Unusable

Move From HI Register**MFHI**

31	26 25	16 15	11 10	6 5	0
SPECIAL 000000	0 00 0000 0000	rd	0 00000	MFHI 010000	
6	10	5	5	6	

Format: MFHI rd**MIPS32 (MIPS I)****Purpose:**To copy the special purpose *HI* register to a GPR**Description:** rd ← HIThe contents of special register *HI* are loaded into GPR *rd*.**Restrictions:**

None

Operation:

GPR[rd] ← HI

Exceptions:

None

Historical Information:

In the MIPS I, II, and III architectures, the two instructions which follow the MFHI must not modify the HI register. If this restriction is violated, the result of the MFHI is **UNPREDICTABLE**. This restriction was removed in MIPS IV and MIPS32, and all subsequent levels of the architecture.

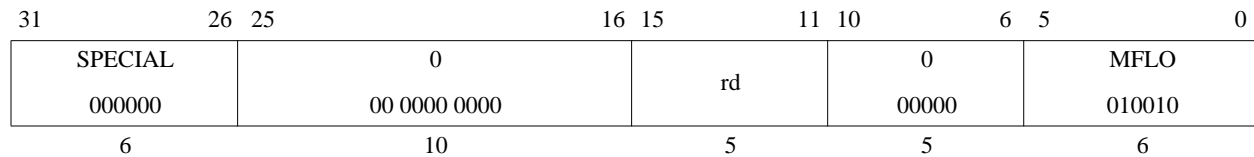
Move From LO Register**MFLO****Format:** MFLO rd**MIPS32 (MIPS I)****Purpose:**To copy the special purpose *LO* register to a GPR**Description:** $rd \leftarrow LO$ The contents of special register *LO* are loaded into GPR *rd*.**Restrictions:** None**Operation:** $GPR[rd] \leftarrow LO$ **Exceptions:**

None

Historical Information:

In the MIPS I, II, and III architectures, the two instructions which follow the MFHI must not modify the HI register. If this restriction is violated, the result of the MFHI is **UNPREDICTABLE**. This restriction was removed in MIPS IV and MIPS32, and all subsequent levels of the architecture.

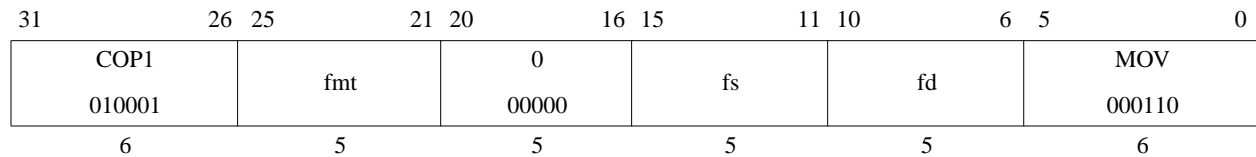

Format: MOV.S *fd*, *fs* MIPS32 (MIPS I)

MOV.D *fd*, *fs* MIPS32 (MIPS I)

Purpose:

To move an FP value between FPRs

Description: $fd \leftarrow fs$

The value in FPR *fs* is placed into FPR *fd*. The source and destination are values in format *fmt*.

The move is non-arithmetic; it causes no IEEE 754 exceptions.

Restrictions:

The fields *fs* and *fd* must specify FPRs valid for operands of type *fmt*; if they are not valid, the result is **UNPREDICTABLE**.

The operand must be a value in format *fmt*; if it is not, the result is **UNPREDICTABLE** and the value of the operand FPR becomes **UNPREDICTABLE**.

Operation:

`StoreFPR(fd, fmt, ValueFPR(fs, fmt))`

Exceptions:

Coprocessor Unusable, Reserved Instruction

Floating Point Exceptions:

Unimplemented Operation

Move Conditional on Floating Point False

MOVF

31	26 25	21 20	18 17 16 15	11 10	6 5	0
SPECIAL 000000	rs	cc	0 0 tf	rd	0 00000	MOVCI 000001
6	5	3	1 1	5	5	6

Format: MOVF rd, rs, cc

MIPS32 (MIPS IV)

Purpose:

To test an FP condition code then conditionally move a GPR

Description: if cc = 0 then rd ← rs

If the floating point condition code specified by *CC* is zero, then the contents of GPR *rs* are placed into GPR *rd*.

Restrictions:

Operation:

```
if FPConditionCode(cc) = 0 then
    GPR[rd] ← GPR[rs]
endif
```

Exceptions:

Reserved Instruction, Coprocessor Unusable

31	26 25	21 20	18 17 16 15	11 10	6 5	0
COP1 010001	fmt	cc	0 0 tf	fs	fd	MOVCF 010001
6	5	3	1 1	5	5	6

Format: MOVF.S *fd*, *fs*, *cc* **MIPS32 (MIPS IV)**

MOVF.D *fd*, *fs*, *cc* **MIPS32 (MIPS IV)**

Purpose:

To test an FP condition code then conditionally move an FP value

Description: if *cc* = 0 then *fd* ← *fs*

If the floating point condition code specified by *CC* is zero, then the value in FPR *fs* is placed into FPR *fd*. The source and destination are values in format *fmt*.

If the condition code is not zero, then FPR *fs* is not copied and FPR *fd* retains its previous value in format *fmt*. If *fd* did not contain a value either in format *fmt* or previously unused data from a load or move-to operation that could be interpreted in format *fmt*, then the value of *fd* becomes **UNPREDICTABLE**.

The move is non-arithmetic; it causes no IEEE 754 exceptions.

Restrictions:

The fields *fs* and *fd* must specify FPRs valid for operands of type *fmt*; if they are not valid, the result is **UNPREDICTABLE**. The operand must be a value in format *fmt*; if it is not, the result is **UNPREDICTABLE** and the value of the operand FPR becomes **UNPREDICTABLE**.

Operation:

```
if FPConditionCode(cc) = 0 then
  StoreFPR(fd, fmt, ValueFPR(fs, fmt))
else
  StoreFPR(fd, fmt, ValueFPR(fd, fmt))
```

Exceptions:

Coprocessor Unusable, Reserved Instruction

Floating Point Exceptions:

Unimplemented Operation

Move Conditional on Not Zero**MOVN**

31	26	25	21	20	16	15	11	10	6	5	0
SPECIAL 000000	rs		rt		rd		0 00000		MOVN 001011		
6	5		5		5		5		6		

Format: `MOVN rd, rs, rt`**MIPS32 (MIPS IV)****Purpose:**

To conditionally move a GPR after testing a GPR value

Description: `if rt \neq 0 then rd \leftarrow rs`If the value in GPR *rt* is not equal to zero, then the contents of GPR *rs* are placed into GPR *rd*.**Restrictions:**

None

Operation:

```
if GPR[rt]  $\neq$  0 then
  GPR[rd]  $\leftarrow$  GPR[rs]
endif
```

Exceptions:

None

Programming Notes:The non-zero value tested here is the *condition true* result from the SLT, SLTI, SLTU, and SLTIU comparison instructions.

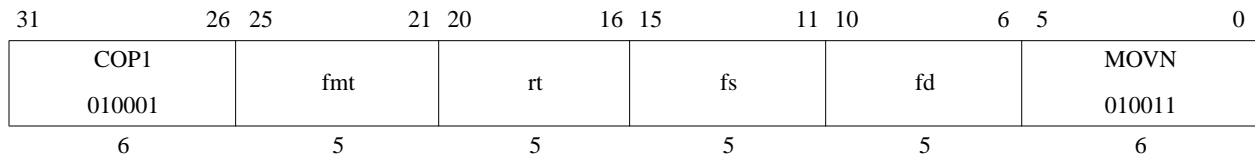

Format: MOVN.S *fd*, *fs*, *rt*
 MOVN.D *fd*, *fs*, *rt*

MIPS32 (MIPS IV)
MIPS32 (MIPS IV)

Purpose:

To test a GPR then conditionally move an FP value

Description: if *rt* ≠ 0 then *fd* ← *fs*

If the value in GPR *rt* is not equal to zero, then the value in FPR *fs* is placed in FPR *fd*. The source and destination are values in format *fmt*.

If GPR *rt* contains zero, then FPR *fs* is not copied and FPR *fd* contains its previous value in format *fmt*. If *fd* did not contain a value either in format *fmt* or previously unused data from a load or move-to operation that could be interpreted in format *fmt*, then the value of *fd* becomes **UNPREDICTABLE**.

The move is non-arithmetic; it causes no IEEE 754 exceptions.

Restrictions:

The fields *fs* and *fd* must specify FPRs valid for operands of type *fmt*; if they are not valid, the result is **UNPREDICTABLE**.

The operand must be a value in format *fmt*; if it is not, the result is **UNPREDICTABLE** and the value of the operand FPR becomes **UNPREDICTABLE**.

Operation:

```
if GPR[rt] ≠ 0 then
    StoreFPR(fd, fmt, ValueFPR(fs, fmt))
else
    StoreFPR(fd, fmt, ValueFPR(fd, fmt))
endif
```

Exceptions:

Coprocessor Unusable, Reserved Instruction

Floating Point Exceptions:

Unimplemented Operation

Move Conditional on Floating Point True

MOVT

31	26 25	21 20	18 17 16 15	11 10	6 5	0
SPECIAL 000000	rs	cc	0 1 0 1	rd	0 00000	MOVCI 000001
6	5	3	1 1	5	5	6

Format: MOVT rd, rs, cc

MIPS32 (MIPS IV)

Purpose:

To test an FP condition code then conditionally move a GPR

Description: if cc = 1 then rd ← rs

If the floating point condition code specified by *CC* is one, then the contents of GPR *rs* are placed into GPR *rd*.

Restrictions:

Operation:

```

if FPConditionCode(cc) = 1 then
    GPR[rd] ← GPR[rs]
endif
    
```

Exceptions:

Reserved Instruction, Coprocessor Unusable

Floating Point Move Conditional on Floating Point True

MOVT.fmt

31	26 25	21 20	18 17 16 15	11 10	6 5	0
COP1 010001	fmt	cc	0 tf 0 1	fs	fd	MOVCF 010001
6	5	3	1 1	5	5	6

Format: MOVT.S *fd*, *fs*, *cc*
MOVT.D *fd*, *fs*, *cc*

MIPS32 (MIPS IV)
MIPS32 (MIPS IV)

Purpose:

To test an FP condition code then conditionally move an FP value

Description: if *cc* = 1 then *fd* ← *fs*

If the floating point condition code specified by *CC* is one, then the value in FPR *fs* is placed into FPR *fd*. The source and destination are values in format *fmt*.

If the condition code is not one, then FPR *fs* is not copied and FPR *fd* contains its previous value in format *fmt*. If *fd* did not contain a value either in format *fmt* or previously unused data from a load or move-to operation that could be interpreted in format *fmt*, then the value of *fd* becomes undefined.

The move is non-arithmetic; it causes no IEEE 754 exceptions.

Restrictions:

The fields *fs* and *fd* must specify FPRs valid for operands of type *fmt*; if they are not valid, the result is **UNPREDICTABLE**. The operand must be a value in format *fmt*; if it is not, the result is **UNPREDICTABLE** and the value of the operand FPR becomes **UNPREDICTABLE**.

Operation:

```
if FPConditionCode(cc) = 0 then
    StoreFPR(fd, fmt, ValueFPR(fs, fmt))
else
    StoreFPR(fd, fmt, ValueFPR(fd, fmt))
endif
```

Exceptions:

Coprocessor Unusable, Reserved Instruction

Floating Point Exceptions:

Unimplemented Operation

31	26 25	21 20	16 15	11 10	6 5	0
SPECIAL 000000	rs	rt	rd	0 00000	MOVZ 001010	
6	5	5	5	5	6	

Format: MOVZ rd, rs, rt

MIPS32 (MIPS IV)

Purpose:

To conditionally move a GPR after testing a GPR value

Description: if $rt = 0$ then $rd \leftarrow rs$

If the value in GPR *rt* is equal to zero, then the contents of GPR *rs* are placed into GPR *rd*.

Restrictions:

None

Operation:

```
if GPR[rt] = 0 then
    GPR[rd] ← GPR[rs]
endif
```

Exceptions:

None

Programming Notes:

The zero value tested here is the *condition false* result from the SLT, SLTI, SLTU, and SLTIU comparison instructions.

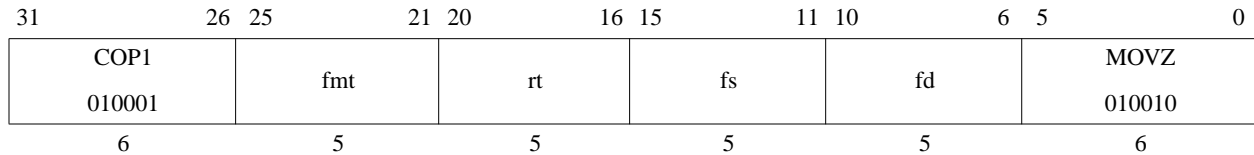

Format: MOVZ.S *fd*, *fs*, *rt*
 MOVZ.D *fd*, *fs*, *rt*

MIPS32 (MIPS IV)
MIPS32 (MIPS IV)

Purpose:

To test a GPR then conditionally move an FP value

Description: if *rt* = 0 then *fd* ← *fs*

If the value in GPR *rt* is equal to zero then the value in FPR *fs* is placed in FPR *fd*. The source and destination are values in format *fmt*.

If GPR *rt* is not zero, then FPR *fs* is not copied and FPR *fd* contains its previous value in format *fmt*. If *fd* did not contain a value either in format *fmt* or previously unused data from a load or move-to operation that could be interpreted in format *fmt*, then the value of *fd* becomes **UNPREDICTABLE**.

The move is non-arithmetic; it causes no IEEE 754 exceptions.

Restrictions:

The fields *fs* and *fd* must specify FPRs valid for operands of type *fmt*; if they are not valid, the result is **UNPREDICTABLE**.

The operand must be a value in format *fmt*; if it is not, the result is **UNPREDICTABLE** and the value of the operand FPR becomes **UNPREDICTABLE**.

Operation:

```
if GPR[rt] = 0 then
    StoreFPR(fd, fmt, ValueFPR(fs, fmt))
else
    StoreFPR(fd, fmt, ValueFPR(fd, fmt))
endif
```

Exceptions:

Coprocessor Unusable, Reserved Instruction

Floating Point Exceptions:

Unimplemented Operation

Multiply and Subtract Word to Hi,Lo**MSUB**

31	26 25	21 20	16 15	11 10	6 5	0
SPECIAL2	rs	rt	0	0	MSUB	
011100			00000	00000	000100	
6	5	5	5	5	6	

Format: MSUB *rs*, *rt***MIPS32****Purpose:**

To multiply two words and subtract the result from Hi, Lo

Description: $(LO, HI) \leftarrow (rs \times rt) - (LO, HI)$

The 32-bit word value in GPR *rs* is multiplied by the 32-bit value in GPR *rt*, treating both operands as signed values, to produce a 64-bit result. The product is subtracted from the 64-bit concatenated values of *HI* and *LO*. The most significant 32 bits of the result are written into *HI* and the least significant 32 bits are written into *LO*. No arithmetic exception occurs under any circumstances.

Restrictions:

None

This instruction does not provide the capability of writing directly to a target GPR.

Operation:

```
temp ← (HI || LO) - (GPR[rs] * GPR[rt])
HI ← temp63..32
LO ← temp31..0
```

Exceptions:

None

Programming Notes:

Where the size of the operands are known, software should place the shorter operand in GPR *rt*. This may reduce the latency of the instruction on those processors which implement data-dependent instruction latencies.

31	26 25	21 20	16 15	11 10	6 5	0
SPECIAL2 011100	rs	rt	0 00000	0 00000	MSUBU 000101	
6	5	5	5	5	6	

Format: MSUBU *rs*, *rt*

MIPS32

Purpose:

To multiply two words and subtract the result from Hi, Lo

Description: $(LO, HI) \leftarrow (rs \times rt) - (LO, HI)$

The 32-bit word value in GPR *rs* is multiplied by the 32-bit word value in GPR *rt*, treating both operands as unsigned values, to produce a 64-bit result. The product is subtracted from the 64-bit concatenated values of *HI* and *LO*. The most significant 32 bits of the result are written into *HI* and the least significant 32 bits are written into *LO*. No arithmetic exception occurs under any circumstances.

Restrictions:

None

This instruction does not provide the capability of writing directly to a target GPR.

Operation:

```
temp ← (HI || LO) - (GPR[rs] * GPR[rt])
HI ← temp63..32
LO ← temp31..0
```

Exceptions:

None

Programming Notes:

Where the size of the operands are known, software should place the shorter operand in GPR *rt*. This may reduce the latency of the instruction on those processors which implement data-dependent instruction latencies.

31	26 25	21 20	16 15	11 10	3 2 0
COP0 010000	MT 00100	rt	rd	0 0000 000	sel
6	5	5	5	8	3

Format: MTC0 *rt*, *rd*

MIPS32

Purpose:

To move the contents of a general register to a coprocessor 0 register.

Description: $CPR[r0, rd, sel] \leftarrow rt$

The contents of general register *rt* are loaded into the coprocessor 0 register specified by the combination of *rd* and *sel*. Not all coprocessor 0 registers support the the *sel* field. In those instances, the *sel* field must be set to zero.

Restrictions:

The results are **UNDEFINED** if coprocessor 0 does not contain a register as specified by *rd* and *sel*.

Operation:

$CPR[0, rd, sel] \leftarrow data$

Exceptions:

Coprocessor Unusable

Reserved Instruction

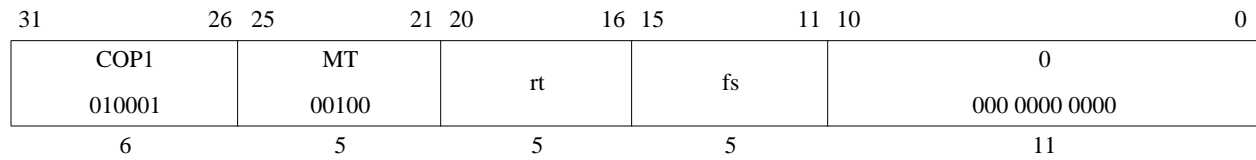

Format: MTC1 *rt*, *fs*

MIPS32 (MIPS I)

Purpose:

To copy a word from a GPR to an FPU (CPI) general register

Description: $fs \leftarrow rt$

The low word in GPR *rt* is placed into the low word of floating point (Coprocessor 1) general register *fs*.

Restrictions:

Operation:

```
data ← GPR[rt]31..0
StoreFPR(fs, UNINTERPRETED_WORD, data)
```

Exceptions:

Coprocessor Unusable

Historical Information:

For MIPS I, MIPS II, and MIPS III the value of FPR *fs* is UNPREDICTABLE for the instruction immediately following MTC1.

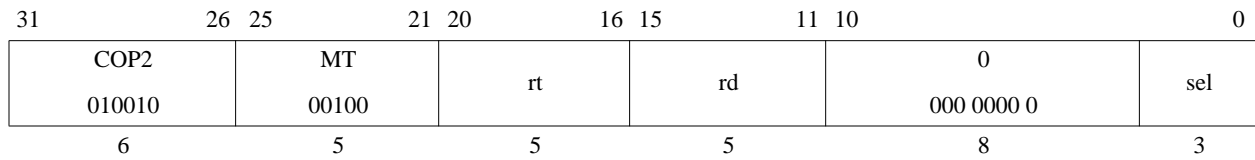
Move Word to Coprocessor 2**MTC2**

Format: MTC2 *rt*, *rd*
MTC2 *rt*, *rd*, *sel*

MIPS32
MIPS32

Purpose:

To copy a word from a GPR to a COP2 general register

Description: $rd \leftarrow rt$

The low word in GPR *rt* is placed into the low word of coprocessor 2 general register specified by the *rd* and *sel* fields. Note that not all coprocessor 2 registers may support the *sel* field. In those instances, the *sel* field must be zero.

Restrictions:

The results are **UNPREDICTABLE** if coprocessor 2 does not contain a register as specified by *rd* and *sel*.

Operation:

$data \leftarrow GPR[rt]_{31..0}$
 $CPR[2,rd,sel] \leftarrow data$

Exceptions:

Coprocessor Unusable

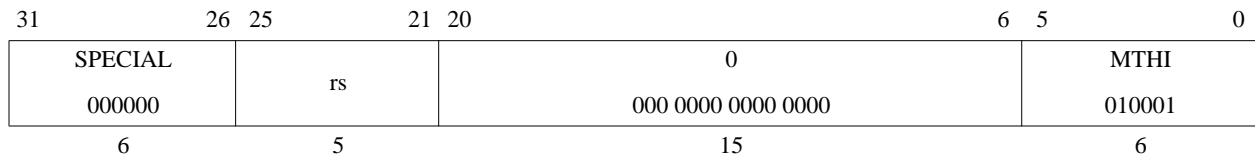

Format: MTHI rs

MIPS32 (MIPS I)

Purpose:

To copy a GPR to the special purpose *HI* register

Description: $HI \leftarrow rs$

The contents of GPR *rs* are loaded into special register *HI*.

Restrictions:

A computed result written to the *HI/LO* pair by DIV, DIVU, MULT, or MULTU must be read by MFHI or MFLO before a new result can be written into either *HI* or *LO*.

If an MTHI instruction is executed following one of these arithmetic instructions, but before an MFLO or MFHI instruction, the contents of *LO* are UNPREDICTABLE. The following example shows this illegal situation:

```
MUL   r2,r4 # start operation that will eventually write to HI,LO
...   # code not containing mfhi or mflo
MTHI  r6
...   # code not containing mflo
MFLO  r3    # this mflo would get an UNPREDICTABLE value
```

Operation:

$HI \leftarrow GPR[rs]$

Exceptions:

None

Historical Information:

In MIPS I-III, if either of the two preceding instructions is MFHI, the result of that MFHI is UNPREDICTABLE. Reads of the *HI* or *LO* special register must be separated from any subsequent instructions that write to them by two or more instructions. In MIPS IV and later, including MIPS32 and MIPS64, this restriction does not exist.

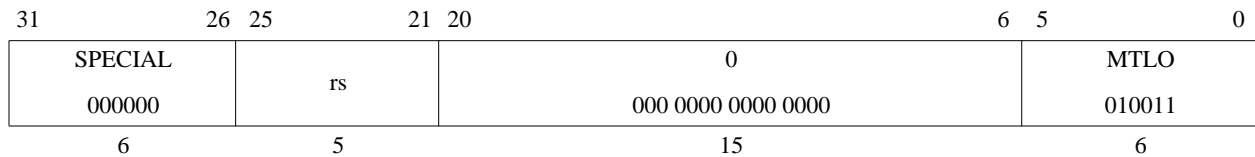

Format: MTLO rs

MIPS32 (MIPS I)

Purpose:

To copy a GPR to the special purpose *LO* register

Description: $LO \leftarrow rs$

The contents of GPR *rs* are loaded into special register *LO*.

Restrictions:

A computed result written to the *HI/LO* pair by DIV, DIVU, MULT, or MULTU must be read by MFHI or MFLO before a new result can be written into either *HI* or *LO*.

If an MTLO instruction is executed following one of these arithmetic instructions, but before an MFLO or MFHI instruction, the contents of *HI* are UNPREDICTABLE. The following example shows this illegal situation:

```
MUL   r2,r4 # start operation that will eventually write to HI,LO
...   # code not containing mfhi or mflo
MTLO  r6
...   # code not containing mfhi
MFHI  r3    # this mfhi would get an UNPREDICTABLE value
```

Operation:

$LO \leftarrow GPR[rs]$

Exceptions:

None

Historical Information:

In MIPS I-III, if either of the two preceding instructions is MFHI, the result of that MFHI is UNPREDICTABLE. Reads of the *HI* or *LO* special register must be separated from any subsequent instructions that write to them by two or more instructions. In MIPS IV and later, including MIPS32 and MIPS64, this restriction does not exist.

Multiply Word to GPR**MUL**

31	26 25	21 20	16 15	11 10	6 5	0
SPECIAL2	rs	rt	rd	0	MUL	
011100				00000	000010	
6	5	5	5	5	6	

Format: MUL rd, rs, rt**MIPS32****Purpose:**

To multiply two words and write the result to a GPR.

Description: $rd \leftarrow rs \times rt$

The 32-bit word value in GPR *rs* is multiplied by the 32-bit value in GPR *rt*, treating both operands as signed values, to produce a 64-bit result. The least significant 32 bits of the product are written to GPR *rd*. The contents of *HI* and *LO* are **UNPREDICTABLE** after the operation. No arithmetic exception occurs under any circumstances.

Restrictions:

Note that this instruction does not provide the capability of writing the result to the HI and LO registers.

Operation:

```
temp <- GPR[rs] * GPR[rt]
GPR[rd] <- temp31..0
HI <- UNPREDICTABLE
LO <- UNPREDICTABLE
```

Exceptions:

None

Programming Notes:

In some processors the integer multiply operation may proceed asynchronously and allow other CPU instructions to execute before it is complete. An attempt to read *LO* or *HI* before the results are written interlocks until the results are ready. Asynchronous execution does not affect the program result, but offers an opportunity for performance improvement by scheduling the multiply so that other instructions can execute in parallel.

Programs that require overflow detection must check for it explicitly.

Where the size of the operands are known, software should place the shorter operand in GPR *rt*. This may reduce the latency of the instruction on those processors which implement data-dependent instruction latencies.

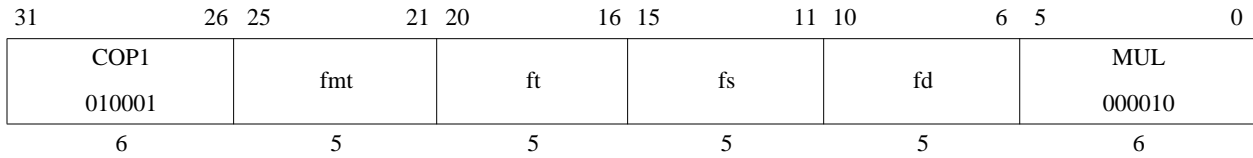

Format: MUL.S *fd, fs, ft*
MUL.D *fd, fs, ft*

MIPS32 (MIPS I)
MIPS32 (MIPS I)

Purpose:

To multiply FP values

Description: $fd \leftarrow fs \times ft$

The value in FPR *fs* is multiplied by the value in FPR *ft*. The result is calculated to infinite precision, rounded according to the current rounding mode in *FCSR*, and placed into FPR *fd*. The operands and result are values in format *fmt*.

Restrictions:

The fields *fs*, *ft*, and *fd* must specify FPRs valid for operands of type *fmt*; if they are not valid, the result is **UNPREDICTABLE**.

The operands must be values in format *fmt*; if they are not, the result is **UNPREDICTABLE** and the value of the operand FPRs becomes **UNPREDICTABLE**.

Operation:

$$\text{StoreFPR}(fd, fmt, \text{ValueFPR}(fs, fmt) \times_{fmt} \text{ValueFPR}(ft, fmt))$$

Exceptions:

Coprocessor Unusable, Reserved Instruction

Floating Point Exceptions:

Inexact, Unimplemented Operation, Invalid Operation, Overflow, Underflow

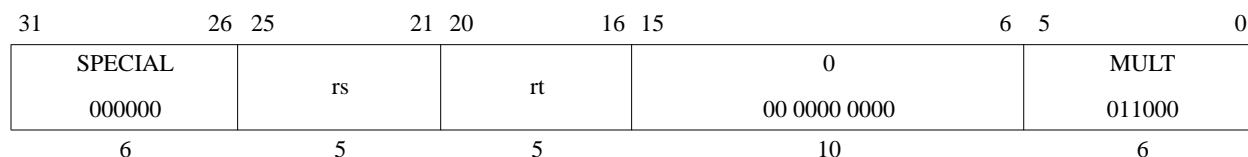

Format: MULT *rs*, *rt*

MIPS32 (MIPS I)

Purpose:

To multiply 32-bit signed integers

Description: (LO, HI) $\leftarrow rs \times rt$

The 32-bit word value in GPR *rt* is multiplied by the 32-bit value in GPR *rs*, treating both operands as signed values, to produce a 64-bit result. The low-order 32-bit word of the result is placed into special register *LO*, and the high-order 32-bit word is splaced into special register *HI*.

No arithmetic exception occurs under any circumstances.

Restrictions:

None

Operation:

```

prod   $\leftarrow$  GPR[rs]31..0  $\times$  GPR[rt]31..0
LO     $\leftarrow$  prod31..0
HI     $\leftarrow$  prod63..32

```

Exceptions:

None

Programming Notes:

In some processors the integer multiply operation may proceed asynchronously and allow other CPU instructions to execute before it is complete. An attempt to read *LO* or *HI* before the results are written interlocks until the results are ready. Asynchronous execution does not affect the program result, but offers an opportunity for performance improvement by scheduling the multiply so that other instructions can execute in parallel.

Programs that require overflow detection must check for it explicitly.

Where the size of the operands are known, software should place the shorter operand in GPR *rt*. This may reduce the latency of the instruction on those processors which implement data-dependent instruction latencies.

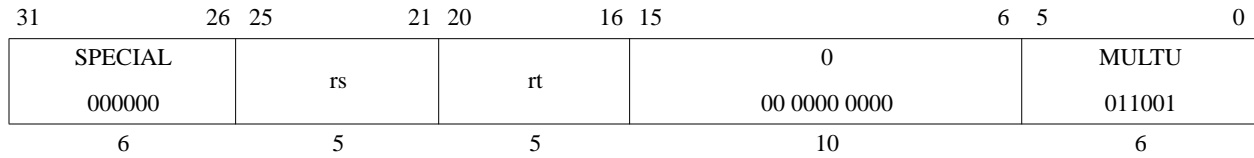

Format: MULTU *rs*, *rt*

MIPS32 (MIPS I)

Purpose:

To multiply 32-bit unsigned integers

Description: $(LO, HI) \leftarrow rs \times rt$

The 32-bit word value in GPR *rt* is multiplied by the 32-bit value in GPR *rs*, treating both operands as unsigned values, to produce a 64-bit result. The low-order 32-bit word of the result is placed into special register *LO*, and the high-order 32-bit word is placed into special register *HI*.

No arithmetic exception occurs under any circumstances.

Restrictions:

None

Operation:

```

prod ← (0 || GPR[rs]31..0) × (0 || GPR[rt]31..0)
LO ← prod31..0
HI ← prod63..32
    
```

Exceptions:

None

Programming Notes:

In some processors the integer multiply operation may proceed asynchronously and allow other CPU instructions to execute before it is complete. An attempt to read *LO* or *HI* before the results are written interlocks until the results are ready. Asynchronous execution does not affect the program result, but offers an opportunity for performance improvement by scheduling the multiply so that other instructions can execute in parallel.

Programs that require overflow detection must check for it explicitly.

Where the size of the operands are known, software should place the shorter operand in GPR *rt*. This may reduce the latency of the instruction on those processors which implement data-dependent instruction latencies.

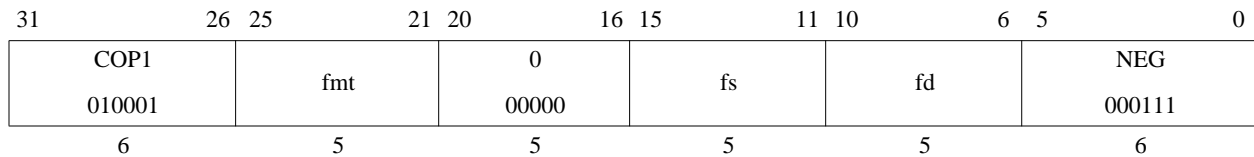

Format: NEG.S *fd*, *fs*
 NEG.D *fd*, *fs*

MIPS32 (MIPS I)
MIPS32 (MIPS I)

Purpose:

To negate an FP value

Description: $fd \leftarrow -fs$

The value in FPR *fs* is negated and placed into FPR *fd*. The value is negated by changing the sign bit value. The operand and result are values in format *fmt*. This operation is arithmetic; a NaN operand signals invalid operation.

Restrictions:

The fields *fs* and *fd* must specify FPRs valid for operands of type *fmt*; if they are not valid, the result is **UNPREDICTABLE**. The operand must be a value in format *fmt*; if it is not, the result is **UNPREDICTABLE** and the value of the operand FPR becomes **UNPREDICTABLE**.

Operation:

`StoreFPR(fd, fmt, Negate(ValueFPR(fs, fmt)))`

Exceptions:

Coprocessor Unusable, Reserved Instruction

Floating Point Exceptions:

Unimplemented Operation, Invalid Operation

No Operation**NOP**

31	26	25	21	20	16	15	11	10	6	5	0
SPECIAL	0		0		0		0		SLL		
000000	00000		00000		00000		00000		000000		
6	5		5		5		5		6		

Format: NOP**Assembly Idiom****Purpose:**

To perform no operation.

Description:

NOP is the assembly idiom used to denote no operation. The actual instruction is interpreted by the hardware as SLL r0, r0, 0.

Restrictions:

None

Operation:

None

Exceptions:

None

Programming Notes:

The zero instruction word, which represents SLL, r0, r0, 0, is the preferred NOP for software to use to fill branch and jump delay slots and to pad out alignment sequences.

31	26 25	21 20	16 15	11 10	6 5	0
SPECIAL 000000	rs	rt	rd	0 00000	NOR 100111	
6	5	5	5	5	6	

Format: NOR *rd*, *rs*, *rt*

MIPS32 (MIPS I)

Purpose:

To do a bitwise logical NOT OR

Description: $rd \leftarrow rs \text{ NOR } rt$

The contents of GPR *rs* are combined with the contents of GPR *rt* in a bitwise logical NOR operation. The result is placed into GPR *rd*.

Restrictions:

None

Operation:

$GPR[rd] \leftarrow GPR[rs] \text{ nor } GPR[rt]$

Exceptions:

None

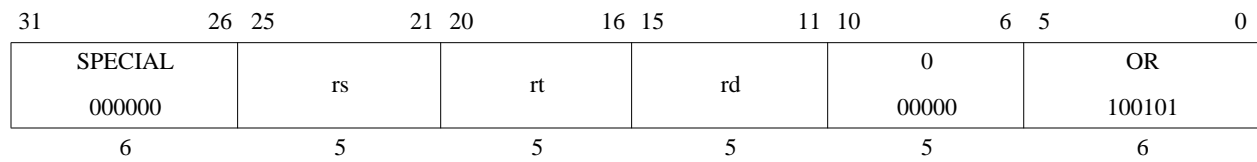

Format: OR *rd*, *rs*, *rt*

MIPS32 (MIPS I)

Purpose:

To do a bitwise logical OR

Description: $rd \leftarrow rs \text{ or } rt$

The contents of GPR *rs* are combined with the contents of GPR *rt* in a bitwise logical OR operation. The result is placed into GPR *rd*.

Restrictions:

None

Operation:

$GPR[rd] \leftarrow GPR[rs] \text{ or } GPR[rt]$

Exceptions:

None

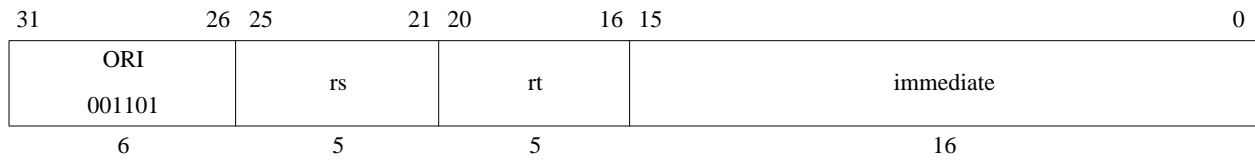

Format: ORI *rt*, *rs*, *immediate*

MIPS32 (MIPS I)

Purpose:

To do a bitwise logical OR with a constant

Description: $rt \leftarrow rs \text{ or } \textit{immediate}$

The 16-bit *immediate* is zero-extended to the left and combined with the contents of GPR *rs* in a bitwise logical OR operation. The result is placed into GPR *rt*.

Restrictions:

None

Operation:

$GPR[rt] \leftarrow GPR[rs] \text{ or } \textit{zero_extend(immediate)}$

Exceptions:

None

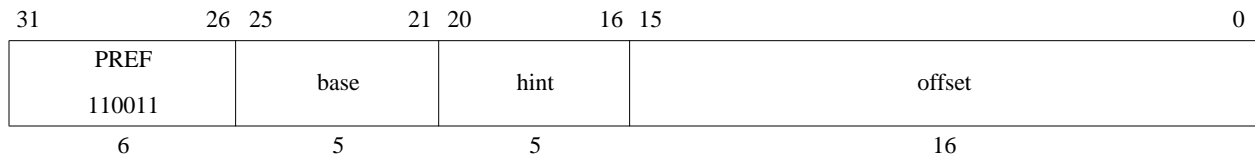

Format: `PREF hint,offset(base)`

MIPS32 (MIPS IV)

Purpose:

To move data between memory and cache.

Description: `prefetch_memory(base+offset)`

PREF adds the 16-bit signed *offset* to the contents of GPR *base* to form an effective byte address. The *hint* field supplies information about the way that the data is expected to be used.

PREF enables the processor to take some action, typically prefetching the data into cache, to improve program performance. The action taken for a specific PREF instruction is both system and context dependent. Any action, including doing nothing, is permitted as long as it does not change architecturally visible state or alter the meaning of a program. Implementations are expected either to do nothing, or to take an action that increases the performance of the program.

PREF does not cause addressing-related exceptions. If the address specified would cause an addressing exception, the exception condition is ignored and no data movement occurs. However even if no data is prefetched, some action that is not architecturally visible, such as writeback of a dirty cache line, can take place.

PREF never generates a memory operation for a location with an *uncached* memory access type.

If PREF results in a memory operation, the memory access type used for the operation is determined by the memory access type of the effective address, just as it would be if the memory operation had been caused by a load or store to the effective address.

For a cached location, the expected and useful action for the processor is to prefetch a block of data that includes the effective address. The size of the block and the level of the memory hierarchy it is fetched into are implementation specific.

The *hint* field supplies information about the way the data is expected to be used. A *hint* value cannot cause an action to modify architecturally visible state. A processor may use a *hint* value to improve the effectiveness of the prefetch action.

Table 3-29 Values of the *hint* Field for the PREF Instruction

Value	Name	Data Use and Desired Prefetch Action
0	load	Use: Prefetched data is expected to be read (not modified). Action: Fetch data as if for a load.
1	store	Use: Prefetched data is expected to be stored or modified. Action: Fetch data as if for a store.
2-3	Reserved	Reserved for future use - not available to implementations.
4	load_streamed	Use: Prefetched data is expected to be read (not modified) but not reused extensively; it “streams” through cache. Action: Fetch data as if for a load and place it in the cache so that it does not displace data prefetched as “retained.”
5	store_streamed	Use: Prefetched data is expected to be stored or modified but not reused extensively; it “streams” through cache. Action: Fetch data as if for a store and place it in the cache so that it does not displace data prefetched as “retained.”
6	load_retained	Use: Prefetched data is expected to be read (not modified) and reused extensively; it should be “retained” in the cache. Action: Fetch data as if for a load and place it in the cache so that it is not displaced by data prefetched as “streamed.”
7	store_retained	Use: Prefetched data is expected to be stored or modified and reused extensively; it should be “retained” in the cache. Action: Fetch data as if for a store and place it in the cache so that it is not displaced by data prefetched as “streamed.”

Table 3-29 Values of the *hint* Field for the PREF Instruction

8-24	Reserved	Reserved for future use - not available to implementations.
25	writeback_invalidate (also known as “nudge”)	Use: Data is no longer expected to be used. Action: For a writeback cache, schedule a writeback of any dirty data. At the completion of the writeback, mark the state of any cache lines written back as invalid.
26-29	Implementation Dependent	Unassigned by the Architecture - available for implementation-dependent use.
30	PrepareForStore	Use: Prepare the cache for writing an entire line, without the overhead involved in filling the line from memory. Action: If the reference hits in the cache, no action is taken. If the reference misses in the cache, a line is selected for replacement, any valid and dirty victim is written back to memory, the entire line is filled with zero data, and the state of the line is marked as valid and dirty.
31	Implementation Dependent	Unassigned by the Architecture - available for implementation-dependent use.

Restrictions:

None

Operation:

```
vAddr ← GPR[base] + sign_extend(offset)
(pAddr, CCA) ← AddressTranslation(vAddr, DATA, LOAD)
Prefetch(CCA, pAddr, vAddr, DATA, hint)
```

Exceptions:

Prefetch does not take any TLB-related or address-related exceptions under any circumstances.

Programming Notes:

Prefetch cannot prefetch data from a mapped location unless the translation for that location is present in the TLB. Locations in memory pages that have not been accessed recently may not have translations in the TLB, so prefetch may not be effective for such locations.

Prefetch does not cause addressing exceptions. It does not cause an exception to prefetch using an address pointer value before the validity of a pointer is determined.

Hint field encodings whose function is described as “streamed” or “retained” convey usage intent from software to hardware. Software should not assume that hardware will always prefetch data in an optimal way. If data is to be truly retained, software should use the Cache instruction to lock data into the cache.

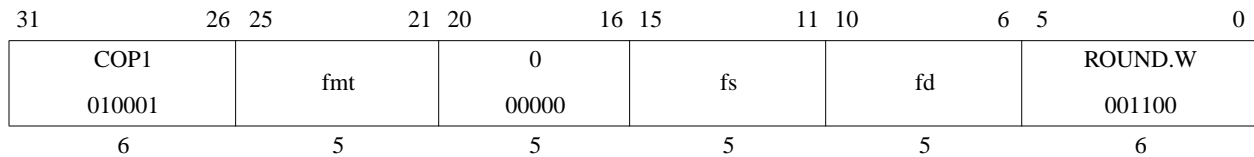

Format: ROUND.W.S fd, fs
 ROUND.W.D fd, fs

MIPS32 (MIPS II)
MIPS32 (MIPS II)

Purpose:

To convert an FP value to 32-bit fixed point, rounding to nearest

Description: $fd \leftarrow \text{convert_and_round}(fs)$

The value in FPR *fs*, in format *fmt*, is converted to a value in 32-bit word fixed point format rounding to nearest/even (rounding mode 0). The result is placed in FPR *fd*.

When the source value is Infinity, NaN, or rounds to an integer outside the range -2^{31} to $2^{31}-1$, the result cannot be represented correctly and an IEEE Invalid Operation condition exists. In this case the Invalid Operation flag is set in the *FCSR*. If the Invalid Operation *Enable* bit is set in the *FCSR*, no result is written to *fd* and an Invalid Operation exception is taken immediately. Otherwise, the default result, $2^{31}-1$, is written to *fd*.

Restrictions:

The fields *fs* and *fd* must specify valid FPRs; *fs* for type *fmt* and *fd* for word fixed point; if they are not valid, the result is **UNPREDICTABLE**.

The operand must be a value in format *fmt*; if it is not, the result is **UNPREDICTABLE** and the value of the operand FPR becomes **UNPREDICTABLE**.

Operation:

`StoreFPR(fd, W, ConvertFmt(ValueFPR(fs, fmt), fmt, W))`

Exceptions:

Coprocessor Unusable, Reserved Instruction

Floating Point Exceptions:

Inexact, Unimplemented Operation, Invalid Operation, Overflow

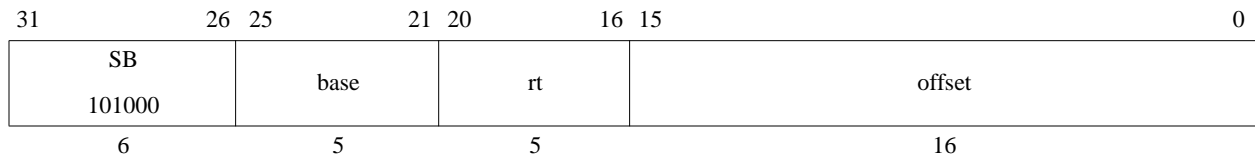

Format: SB *rt*, offset(*base*)

MIPS32 (MIPS I)

Purpose:

To store a byte to memory

Description: $\text{memory}[\text{base}+\text{offset}] \leftarrow \text{rt}$

The least-significant 8-bit byte of GPR *rt* is stored in memory at the location specified by the effective address. The 16-bit signed *offset* is added to the contents of GPR *base* to form the effective address.

Restrictions:

None

Operation:

```

vAddr    ← sign_extend(offset) + GPR[base]
(pAddr, CCA) ← AddressTranslation (vAddr, DATA, STORE)
pAddr    ← pAddrPSIZE-1..2 || (pAddr1..0 xor ReverseEndian2)
bytesel  ← vAddr1..0 xor BigEndianCPU2
dataword ← GPR[rt]31-8*bytesel..0 || 08*bytesel
StoreMemory (CCA, BYTE, dataword, pAddr, vAddr, DATA)

```

Exceptions:

TLB Refill, TLB Invalid, TLB Modified, Bus Error, Address Error

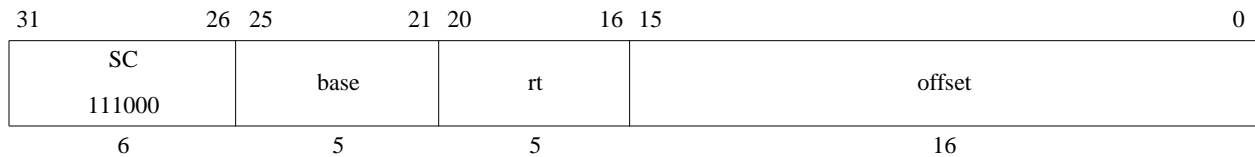

Format: SC *rt*, *offset*(*base*)

MIPS32 (MIPS II)

Purpose:

To store a word to memory to complete an atomic read-modify-write

Description: if `atomic_update` then `memory[base+offset] ← rt`, `rt ← 1` else `rt ← 0`

The LL and SC instructions provide primitives to implement atomic read-modify-write (RMW) operations for cached memory locations.

The 16-bit signed *offset* is added to the contents of GPR *base* to form an effective address.

The SC completes the RMW sequence begun by the preceding LL instruction executed on the processor. To complete the RMW sequence atomically, the following occur:

- The least-significant 32-bit word of GPR *rt* is stored into memory at the location specified by the aligned effective address.
- A 1, indicating success, is written into GPR *rt*.

Otherwise, memory is not modified and a 0, indicating failure, is written into GPR *rt*.

If either of the following events occurs between the execution of LL and SC, the SC fails:

- A coherent store is completed by another processor or coherent I/O module into the block of physical memory containing the word. The size and alignment of the block is implementation dependent, but it is at least one word and at most the minimum page size.
- An exception occurs on the processor executing the LL/SC.

If either of the following events occurs between the execution of LL and SC, the SC may succeed or it may fail; the success or failure is not predictable. Portable programs should not cause one of these events.

- A load, store, or prefetch is executed on the processor executing the LL/SC.
- The instructions executed starting with the LL and ending with the SC do not lie in a 2048-byte contiguous region of virtual memory. The region does not have to be aligned, other than the alignment required for instruction words.

The following conditions must be true or the result of the SC is undefined:

- Execution of SC must have been preceded by execution of an LL instruction.
- A RMW sequence executed without intervening exceptions must use the same address in the LL and SC. The address is the same if the virtual address, physical address, and cache-coherence algorithm are identical.

Atomic RMW is provided only for cached memory locations. The extent to which the detection of atomicity operates correctly depends on the system implementation and the memory access type used for the location:

- **MP atomicity:** To provide atomic RMW among multiple processors, all accesses to the location must be made with a memory access type of *cached coherent*.
- **Uniprocessor atomicity:** To provide atomic RMW on a single processor, all accesses to the location must be made with memory access type of either *cached noncoherent* or *cached coherent*. All accesses must be to one or the other access type, and they may not be mixed.

I/O System: To provide atomic RMW with a coherent I/O system, all accesses to the location must be made with a memory access type of *cached coherent*. If the I/O system does not use coherent memory operations, then atomic RMW cannot be provided with respect to the I/O reads and writes.

Restrictions:

The addressed location must have a memory access type of *cached noncoherent* or *cached coherent*; if it does not, the result is undefined.

The effective address must be naturally-aligned. If either of the 2 least-significant bits of the address is non-zero, an Address Error exception occurs.

Operation:

```
vAddr ← sign_extend(offset) + GPR[base]
if vAddr1..0 ≠ 02 then
    SignalException(AddressError)
endif
(pAddr, CCA) ← AddressTranslation (vAddr, DATA, STORE)
dataword ← GPR[rt]
if LLbit then
    StoreMemory (CCA, WORD, dataword, pAddr, vAddr, DATA)
endif
GPR[rt] ← 031 || LLbit
```

Exceptions:

TLB Refill, TLB Invalid, TLB Modified, Address Error, Reserved Instruction

Programming Notes:

LL and SC are used to atomically update memory locations, as shown below.

```
L1:
    LL    T1, (T0) # load counter
    ADDI  T2, T1, 1 # increment
    SC    T2, (T0) # try to store, checking for atomicity
    BEQ   T2, 0, L1 # if not atomic (0), try again
    NOP                   # branch-delay slot
```

Exceptions between the LL and SC cause SC to fail, so persistent exceptions must be avoided. Some examples of these are arithmetic operations that trap, system calls, and floating point operations that trap or require software emulation assistance.

LL and SC function on a single processor for *cached noncoherent* memory so that parallel programs can be run on uniprocessor systems that do not support *cached coherent* memory access types.

31	26 25	6 5	0
SPECIAL2 011100	code	SDBBP 111111	
6	20	6	

Format: SDBBP code

EJTAG

Purpose:

To cause a debug breakpoint exception

Description:

This instruction causes a debug exception, passing control to the debug exception handler. The code field can be used for passing information to the debug exception handler, and is retrieved by the debug exception handler only by loading the contents of the memory word containing the instruction, using the DEPC register. The CODE field is not used in any way by the hardware.

Restrictions:

Operation:

```

If DebugDM = 0 then
    SignalDebugBreakpointException()
else
    SignalDebugModeBreakpointException()
endif

```

Exceptions:

Debug Breakpoint Exception

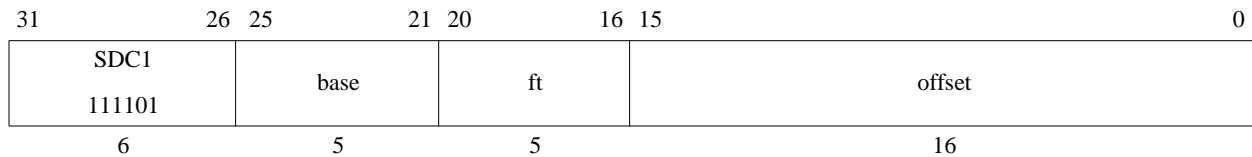

Format: SDC1 ft, offset(base)

MIPS32 (MIPS II)

Purpose:

To store a doubleword from an FPR to memory

Description: $\text{memory}[\text{base}+\text{offset}] \leftarrow \text{ft}$

The 64-bit doubleword in FPR *ft* is stored in memory at the location specified by the aligned effective address. The 16-bit signed *offset* is added to the contents of GPR *base* to form the effective address.

Restrictions:

An Address Error exception occurs if $\text{EffectiveAddress}_{2..0} \neq 0$ (not doubleword-aligned).

Operation:

```

vAddr ← sign_extend(offset) + GPR[base]
if vAddr2..0 ≠ 03 then
    SignalException(AddressError)
endif
(pAddr, CCA) ← AddressTranslation(vAddr, DATA, STORE)
datadoubleword ← ValueFPR(ft, UNINTERPRETED_DOUBLEWORD)
StoreMemory(CCA, DOUBLEWORD, datadoubleword, pAddr, vAddr, DATA)

```

Exceptions:

Coprocessor Unusable, Reserved Instruction, TLB Refill, TLB Invalid, TLB Modified, Address Error

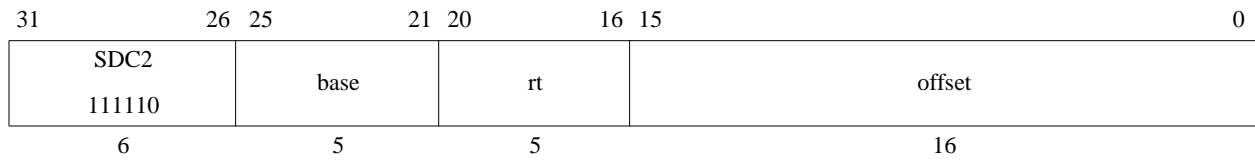

Format: SDC2 *rt*, *offset*(*base*)

MIPS32

Purpose:

To store a doubleword from a Coprocessor 2 register to memory

Description: $\text{memory}[\text{base}+\text{offset}] \leftarrow \text{rt}$

The 64-bit doubleword in Coprocessor 2 register *rt* is stored in memory at the location specified by the aligned effective address. The 16-bit signed *offset* is added to the contents of GPR *base* to form the effective address.

Restrictions:

An Address Error exception occurs if $\text{EffectiveAddress}_{2..0} \neq 0$ (not doubleword-aligned).

Operation:

```

vAddr ← sign_extend(offset) + GPR[base]
if vAddr2..0 ≠ 03 then
    SignalException(AddressError)
endif
(pAddr, CCA) ← AddressTranslation(vAddr, DATA, STORE)
datadoubleword ← CPR[2,rt,0]
StoreMemory(CCA, DOUBLEWORD, datadoubleword, pAddr, vAddr, DATA)

```

Exceptions:

Coprocessor Unusable, Reserved Instruction, TLB Refill, TLB Invalid, TLB Modified, Address Error

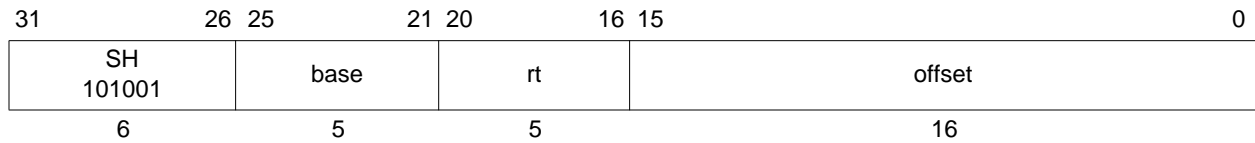

Format: SH *rt*, *offset*(*base*)

MIPS32 (MIPS I)

Purpose:

To store a halfword to memory

Description: $\text{memory}[\text{base}+\text{offset}] \leftarrow \text{rt}$

The least-significant 16-bit halfword of register *rt* is stored in memory at the location specified by the aligned effective address. The 16-bit signed *offset* is added to the contents of GPR *base* to form the effective address.

Restrictions:

The effective address must be naturally-aligned. If the least-significant bit of the address is non-zero, an Address Error exception occurs.

Operation:

```

vAddr ← sign_extend(offset) + GPR[base]
if vAddr0 ≠ 0 then
    SignalException(AddressError)
endif
(pAddr, CCA) ← AddressTranslation (vAddr, DATA, STORE)
pAddr ← pAddrPSIZE-1..2 || (pAddr1..0 xor (ReverseEndian || 0))
bytesel ← vAddr1..0 xor (BigEndianCPU || 0)
dataword ← GPR[rt]31-8*bytesel..0 || 08*bytesel
StoreMemory (CCA, HALFWORD, dataword, pAddr, vAddr, DATA)

```

Exceptions:

TLB Refill, TLB Invalid, TLB Modified, Address Error

Shift Word Left Logical**SLL**

31	26 25	21 20	16 15	11 10	6 5	0
SPECIAL 000000	0 00000	rt	rd	sa	SLL 000000	
6	5	5	5	5	6	

Format: SLL rd, rt, sa**MIPS32 (MIPS I)****Purpose:**

To left-shift a word by a fixed number of bits

Description: $rd \leftarrow rt \ll sa$

The contents of the low-order 32-bit word of GPR *rt* are shifted left, inserting zeros into the emptied bits; the word result is placed in GPR *rd*. The bit-shift amount is specified by *sa*.

Restrictions:

None

Operation:

```

s      ← sa
temp   ← GPR[rt]_{(31-s)..0} || 0s
GPR[rd] ← temp

```

Exceptions:

None

Programming Notes:

SLL r0, r0, 0, expressed as NOP, is the assembly idiom used to denote no operation.

SLL r0, r0, 1, expressed as SSNOP, is the assembly idiom used to denote no operation that causes an issue break on superscalar processors.

Shift Word Left Logical Variable**SLLV**

31	26 25	21 20	16 15	11 10	6 5	0
SPECIAL 000000	rs	rt	rd	0 00000	SLLV 000100	
6	5	5	5	5	6	

Format: SLLV rd, rt, rs**MIPS32 (MIPS I)****Purpose:** To left-shift a word by a variable number of bits**Description:** $rd \leftarrow rt \ll rs$

The contents of the low-order 32-bit word of GPR *rt* are shifted left, inserting zeros into the emptied bits; the result word is placed in GPR *rd*. The bit-shift amount is specified by the low-order 5 bits of GPR *rs*.

Restrictions: None**Operation:**

$$s \leftarrow GPR[rs]_{4..0}$$

$$temp \leftarrow GPR[rt]_{(31-s)..0} \parallel 0^s$$

$$GPR[rd] \leftarrow temp$$
Exceptions: None**Programming Notes:**

None

31	26 25	21 20	16 15	11 10	6 5	0
SPECIAL 000000	rs	rt	rd	0 00000	SLT 101010	
6	5	5	5	5	6	

Format: SLT rd, rs, rt

MIPS32 (MIPS I)

Purpose:

To record the result of a less-than comparison

Description: $rd \leftarrow (rs < rt)$

Compare the contents of GPR *rs* and GPR *rt* as signed integers and record the Boolean result of the comparison in GPR *rd*. If GPR *rs* is less than GPR *rt*, the result is 1 (true); otherwise, it is 0 (false).

The arithmetic comparison does not cause an Integer Overflow exception.

Restrictions:

None

Operation:

```

if GPR[rs] < GPR[rt] then
    GPR[rd] ← 0GPRLEN-1 || 1
else
    GPR[rd] ← 0GPRLEN
endif

```

Exceptions:

None

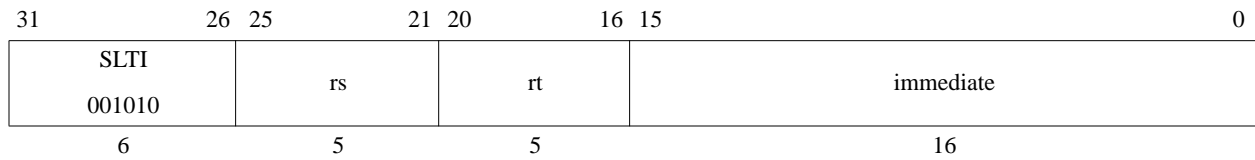

Format: SLTI *rt*, *rs*, *immediate*

MIPS32 (MIPS I)

Purpose:

To record the result of a less-than comparison with a constant

Description: $rt \leftarrow (rs < \text{immediate})$

Compare the contents of GPR *rs* and the 16-bit signed *immediate* as signed integers and record the Boolean result of the comparison in GPR *rt*. If GPR *rs* is less than *immediate*, the result is 1 (true); otherwise, it is 0 (false).

The arithmetic comparison does not cause an Integer Overflow exception.

Restrictions:

None

Operation:

```

if GPR[rs] < sign_extend(immediate) then
    GPR[rd] ← 0GPREN-1 || 1
else
    GPR[rd] ← 0GPREN
endif

```

Exceptions:

None

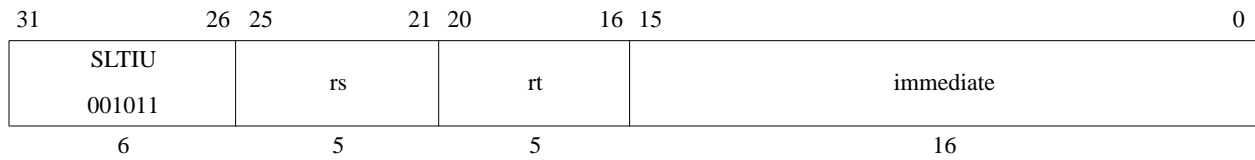

Format: SLTIU *rt*, *rs*, *immediate*

MIPS32 (MIPS I)

Purpose:

To record the result of an unsigned less-than comparison with a constant

Description: $rt \leftarrow (rs < immediate)$

Compare the contents of GPR *rs* and the sign-extended 16-bit *immediate* as unsigned integers and record the Boolean result of the comparison in GPR *rt*. If GPR *rs* is less than *immediate*, the result is 1 (true); otherwise, it is 0 (false).

Because the 16-bit *immediate* is sign-extended before comparison, the instruction can represent the smallest or largest unsigned numbers. The representable values are at the minimum [0, 32767] or maximum [max_unsigned-32767, max_unsigned] end of the unsigned range.

The arithmetic comparison does not cause an Integer Overflow exception.

Restrictions:

None

Operation:

```

if (0 || GPR[rs]) < (0 || sign_extend(immediate)) then
    GPR[rd] ← 0GPREN-1 || 1
else
    GPR[rd] ← 0GPREN
endif

```

Exceptions:

None

31	26 25	21 20	16 15	11 10	6 5	0
SPECIAL 000000	rs	rt	rd	0 00000	SLTU 101011	
6	5	5	5	5	6	

Format: SLTU rd, rs, rt

MIPS32 (MIPS I)

Purpose:

To record the result of an unsigned less-than comparison

Description: $rd \leftarrow (rs < rt)$

Compare the contents of GPR *rs* and GPR *rt* as unsigned integers and record the Boolean result of the comparison in GPR *rd*. If GPR *rs* is less than GPR *rt*, the result is 1 (true); otherwise, it is 0 (false).

The arithmetic comparison does not cause an Integer Overflow exception.

Restrictions:

None

Operation:

```

if (0 || GPR[rs]) < (0 || GPR[rt]) then
    GPR[rd] ← 0GPREN-1 || 1
else
    GPR[rd] ← 0GPREN
endif

```

Exceptions:

None

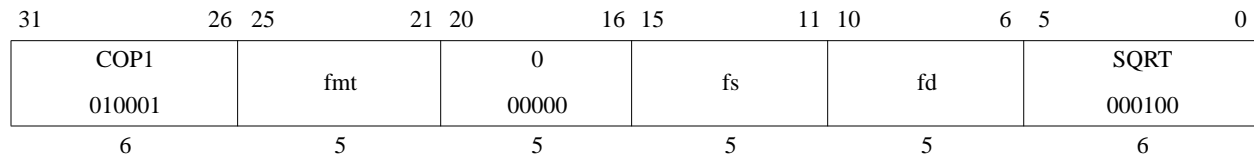

Format: SQRT.S *fd*, *fs*
 SQRT.D *fd*, *fs*

MIPS32 (MIPS II)
MIPS32 (MIPS II)

Purpose:

To compute the square root of an FP value

Description: $fd \leftarrow \text{SQRT}(fs)$

The square root of the value in FPR *fs* is calculated to infinite precision, rounded according to the current rounding mode in *FCSR*, and placed into FPR *fd*. The operand and result are values in format *fmt*.

If the value in FPR *fs* corresponds to -0 , the result is -0 .

Restrictions:

If the value in FPR *fs* is less than 0, an Invalid Operation condition is raised.

The fields *fs* and *fd* must specify FPRs valid for operands of type *fmt*; if they are not valid, the result is **UNPREDICTABLE**.

The operand must be a value in format *fmt*; if it is not, the result is **UNPREDICTABLE** and the value of the operand FPR becomes **UNPREDICTABLE**.

Operation:

`StoreFPR(fd, fmt, SquareRoot(ValueFPR(fs, fmt)))`

Exceptions:

Coprocessor Unusable, Reserved Instruction

Floating Point Exceptions:

Invalid Operation, Inexact, Unimplemented Operation

31	26 25	21 20	16 15	11 10	6 5	0
SPECIAL 000000	0 00000	rt	rd	sa	SRA 000011	
6	5	5	5	5	6	

Format: SRA rd, rt, sa

MIPS32 (MIPS I)

Purpose:

To execute an arithmetic right-shift of a word by a fixed number of bits

Description: $rd \leftarrow rt \gg sa$ (arithmetic)

The contents of the low-order 32-bit word of GPR *rt* are shifted right, duplicating the sign-bit (bit 31) in the emptied bits; the word result is placed in GPR *rd*. The bit-shift amount is specified by *sa*.

Restrictions:

None

Operation:

```

s      ← sa
temp   ← (GPR[rt]31)s || GPR[rt]31..s
GPR[rd] ← temp

```

Exceptions: None

Shift Word Right Arithmetic Variable**SRAV**

31	26 25	21 20	16 15	11 10	6 5	0
SPECIAL 000000	rs	rt	rd	0 00000	SRAV 000111	
6	5	5	5	5	6	

Format: SRAV rd, rt, rs**MIPS32 (MIPS I)****Purpose:**

To execute an arithmetic right-shift of a word by a variable number of bits

Description: $rd \leftarrow rt \gg rs$ (arithmetic)The contents of the low-order 32-bit word of GPR *rt* are shifted right, duplicating the sign-bit (bit 31) in the emptied bits; the word result is placed in GPR *rd*. The bit-shift amount is specified by the low-order 5 bits of GPR *rs*.**Restrictions:**

None

Operation:

```

s      ← GPR[rs]4..0
temp  ← (GPR[rt]31)s || GPR[rt]31..s
GPR[rd] ← temp

```

Exceptions:

None

31	26 25	21 20	16 15	11 10	6 5	0
SPECIAL 000000	0 00000	rt	rd	sa	SRL 000010	
6	5	5	5	5	6	

Format: SRL *rd*, *rt*, *sa*

MIPS32 (MIPS I)

Purpose:

To execute a logical right-shift of a word by a fixed number of bits

Description: $rd \leftarrow rt \gg sa$ (logical)

The contents of the low-order 32-bit word of GPR *rt* are shifted right, inserting zeros into the emptied bits; the word result is placed in GPR *rd*. The bit-shift amount is specified by *sa*.

Restrictions:

None

Operation:

```

s      ← sa
temp  ← 0s || GPR[rt]31..s
GPR[rd] ← temp

```

Exceptions:

None

Shift Word Right Logical Variable**SRLV**

31	26 25	21 20	16 15	11 10	6 5	0
SPECIAL 000000	rs	rt	rd	0 00000	SRLV 000110	
6	5	5	5	5	6	

Format: SRLV rd, rt, rs**MIPS32 (MIPS I)****Purpose:**

To execute a logical right-shift of a word by a variable number of bits

Description: $rd \leftarrow rt \gg rs$ (logical)The contents of the low-order 32-bit word of GPR *rt* are shifted right, inserting zeros into the emptied bits; the word result is placed in GPR *rd*. The bit-shift amount is specified by the low-order 5 bits of GPR *rs*.**Restrictions:**

None

Operation:

```

s      ← GPR[rs]4..0
temp   ← 0s || GPR[rt]31..s
GPR[rd] ← temp

```

Exceptions:

None

31	26 25	21 20	16 15	11 10	6 5	0
SPECIAL	0	0	0	1	SLL	
000000	00000	00000	00000	00001	000000	
6	5	5	5	5	6	

Format: SSNOP**MIPS32****Purpose:**

Break superscalar issue on a superscalar processor.

Description:

SSNOP is the assembly idiom used to denote superscalar no operation. The actual instruction is interpreted by the hardware as SLL r0, r0, 1.

This instruction alters the instruction issue behavior on a superscalar processor by forcing the SSNOP instruction to single-issue. The processor must then end the current instruction issue between the instruction previous to the SSNOP and the SSNOP. The SSNOP then issues alone in the next issue slot.

On a single-issue processor, this instruction is a NOP that takes an issue slot.

Restrictions:

None

Operation:

None

Exceptions:

None

Programming Notes:

SSNOP is intended for use primarily to allow the programmer control over CP0 hazards by converting instructions into cycles in a superscalar processor. For example, to insert at least two cycles between an MTC0 and an ERET, one would use the following sequence:

```

mtc0  x,y
ssnop
ssnop
eret

```

Based on the normal issues rules of the processor, the MTC0 issues in cycle T. Because the SSNOP instructions must issue alone, they may issue no earlier than cycle T+1 and cycle T+2, respectively. Finally, the ERET issues no earlier than cycle T+3. Note that although the instruction after an SSNOP may issue no earlier than the cycle after the SSNOP is issued, that instruction may issue later. This is because other implementation-dependent issue rules may apply that prevent an issue in the next cycle. Processors should not introduce any unnecessary delay in issuing SSNOP instructions.

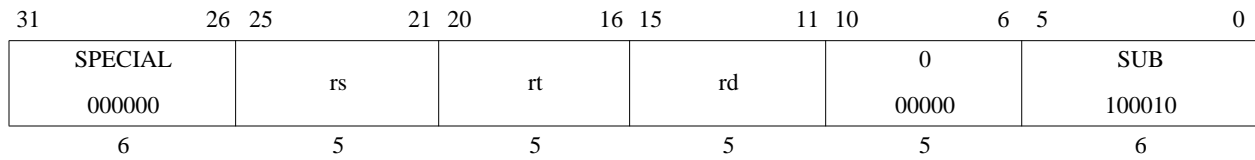
Subtract Word**SUB****Format:** SUB *rd*, *rs*, *rt***MIPS32 (MIPS I)****Purpose:**

To subtract 32-bit integers. If overflow occurs, then trap

Description: $rd \leftarrow rs - rt$

The 32-bit word value in GPR *rt* is subtracted from the 32-bit value in GPR *rs* to produce a 32-bit result. If the subtraction results in 32-bit 2's complement arithmetic overflow, then the destination register is not modified and an Integer Overflow exception occurs. If it does not overflow, the 32-bit result is placed into GPR *rd*.

Restrictions:

None

Operation:

```

temp ← (GPR[rs]31 || GPR[rs]31..0) - (GPR[rt]31 || GPR[rt]31..0)
if temp32 ≠ temp31 then
    SignalException(IntegerOverflow)
else
    GPR[rd] ← temp31..0
endif

```

Exceptions:

Integer Overflow

Programming Notes:

SUBU performs the same arithmetic operation but does not trap on overflow.

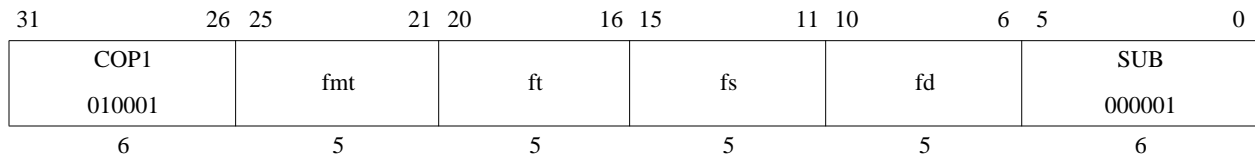

Format: SUB.S *fd*, *fs*, *ft*
 SUB.D *fd*, *fs*, *ft*

MIPS32 (MIPS I)
MIPS32 (MIPS I)

Purpose:

To subtract FP values

Description: $fd \leftarrow fs - ft$

The value in FPR *ft* is subtracted from the value in FPR *fs*. The result is calculated to infinite precision, rounded according to the current rounding mode in *FCSR*, and placed into FPR *fd*. The operands and result are values in format *fmt*. **Restrictions:**

The fields *fs*, *ft*, and *fd* must specify FPRs valid for operands of type *fmt*. If they are not valid, the result is **UNPREDICTABLE**.

The operands must be values in format *fmt*; if they are not, the result is **UNPREDICTABLE** and the value of the operand FPRs becomes **UNPREDICTABLE**.

Operation:

$$\text{StoreFPR} (fd, fmt, \text{ValueFPR}(fs, fmt) -_{fmt} \text{ValueFPR}(ft, fmt))$$

CPU Exceptions:

Coprocessor Unusable, Reserved Instruction

FPU Exceptions:

Inexact, Overflow, Underflow, Invalid Op, Unimplemented Op

Subtract Unsigned Word**SUBU**

31	26 25	21 20	16 15	11 10	6 5	0
SPECIAL 000000	rs	rt	rd	0 00000	SUBU 100011	
6	5	5	5	5	6	

Format: SUBU *rd, rs, rt***MIPS32 (MIPS I)****Purpose:**

To subtract 32-bit integers

Description: $rd \leftarrow rs - rt$

The 32-bit word value in GPR *rt* is subtracted from the 32-bit value in GPR *rs* and the 32-bit arithmetic result is and placed into GPR *rd*.

No integer overflow exception occurs under any circumstances.

Restrictions:

None

Operation:

```
temp ← GPR[rs] - GPR[rt]
GPR[rd] ← temp
```

Exceptions:

None

Programming Notes:

The term “unsigned” in the instruction name is a misnomer; this operation is 32-bit modulo arithmetic that does not trap on overflow. It is appropriate for unsigned arithmetic, such as address arithmetic, or integer arithmetic environments that ignore overflow, such as C language arithmetic.

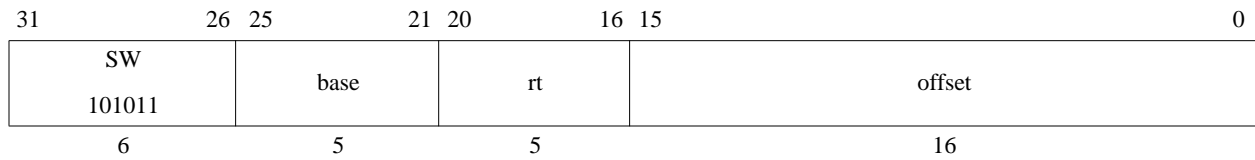

Format: SW *rt*, *offset*(*base*)

MIPS32 (MIPS I)

Purpose:

To store a word to memory

Description: $\text{memory}[\text{base}+\text{offset}] \leftarrow \text{rt}$

The least-significant 32-bit word of register *rt* is stored in memory at the location specified by the aligned effective address. The 16-bit signed *offset* is added to the contents of GPR *base* to form the effective address.

Restrictions:

The effective address must be naturally-aligned. If either of the 2 least-significant bits of the address is non-zero, an Address Error exception occurs.

Operation:

```

vAddr ← sign_extend(offset) + GPR[base]
if vAddr1..0 ≠ 02 then
    SignalException(AddressError)
endif
(pAddr, CCA) ← AddressTranslation (vAddr, DATA, STORE)
dataword ← GPR[rt]
StoreMemory (CCA, WORD, dataword, pAddr, vAddr, DATA)

```

Exceptions:

TLB Refill, TLB Invalid, TLB Modified, Address Error

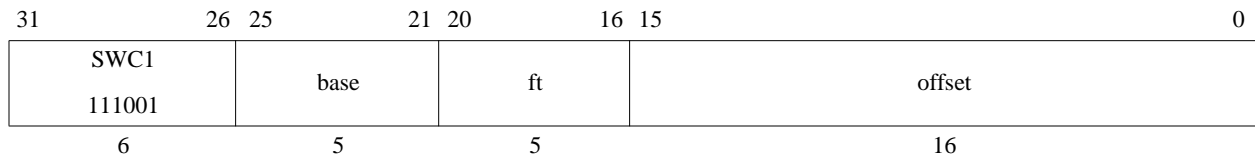

Format: SWC1 ft, offset(base)

MIPS32 (MIPS I)

Purpose:

To store a word from an FPR to memory

Description: $\text{memory}[\text{base}+\text{offset}] \leftarrow \text{ft}$

The low 32-bit word from FPR *ft* is stored in memory at the location specified by the aligned effective address. The 16-bit signed *offset* is added to the contents of GPR *base* to form the effective address.

Restrictions:

An Address Error exception occurs if $\text{EffectiveAddress}_{1..0} \neq 0$ (not word-aligned).

Operation:

```

vAddr ← sign_extend(offset) + GPR[base]
if vAddr1..0 ≠ 03 then
    SignalException(AddressError)
endif
(pAddr, CCA) ← AddressTranslation(vAddr, DATA, STORE)
dataword ← ValueFPR(ft, UNINTERPRETED_WORD)
StoreMemory(CCA, WORD, dataword, pAddr, vAddr, DATA)

```

Exceptions:

Coprocessor Unusable, Reserved Instruction, TLB Refill, TLB Invalid, TLB Modified, Address Error

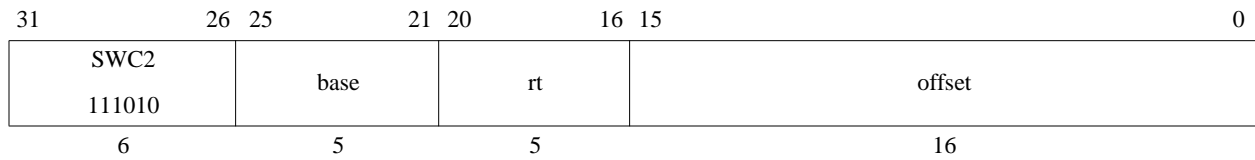

Format: SWC2 *rt*, *offset*(*base*)

MIPS32 (MIPS I)

Purpose:

To store a word from a COP2 register to memory

Description: $\text{memory}[\text{base}+\text{offset}] \leftarrow \text{rt}$

The low 32-bit word from COP2 (Coprocessor 2) register *rt* is stored in memory at the location specified by the aligned effective address. The 16-bit signed *offset* is added to the contents of GPR *base* to form the effective address.

Restrictions:

An Address Error exception occurs if $\text{EffectiveAddress}_{1..0} \neq 0$ (not word-aligned).

Operation:

```

vAddr ← sign_extend(offset) + GPR[base]
if vAddr2..0 ≠ 03 then
    SignalException(AddressError)
endif
(pAddr, CCA) ← AddressTranslation(vAddr, DATA, STORE)
dataword ← CPR[2,rt,0]
StoreMemory(CCA, WORD, dataword, pAddr, vAddr, DATA)

```

Exceptions:

Coprocessor Unusable, Reserved Instruction, TLB Refill, TLB Invalid, TLB Modified, Address Error

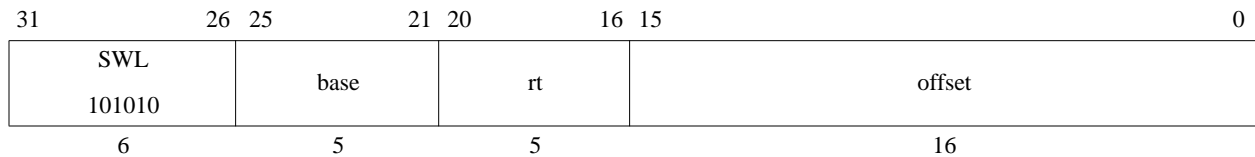

Format: SWL *rt*, *offset*(*base*)

MIPS32 (MIPS I)

Purpose:

To store the most-significant part of a word to an unaligned memory address

Description: $\text{memory}[\text{base}+\text{offset}] \leftarrow \text{rt}$

The 16-bit signed *offset* is added to the contents of GPR *base* to form an effective address (*EffAddr*). *EffAddr* is the address of the most-significant of 4 consecutive bytes forming a word (*W*) in memory starting at an arbitrary byte boundary.

A part of *W*, the most-significant 1 to 4 bytes, is in the aligned word containing *EffAddr*. The same number of the most-significant (left) bytes from the word in GPR *rt* are stored into these bytes of *W*.

The following figure illustrates this operation using big-endian byte ordering for 32-bit and 64-bit registers. The 4 consecutive bytes in 2..5 form an unaligned word starting at location 2. A part of *W*, 2 bytes, is located in the aligned word containing the most-significant byte at 2. First, SWL stores the most-significant 2 bytes of the low word from the source register into these 2 bytes in memory. Next, the complementary SWR stores the remainder of the unaligned word.

Figure 3-6 Unaligned Word Store Using SWL and SWR

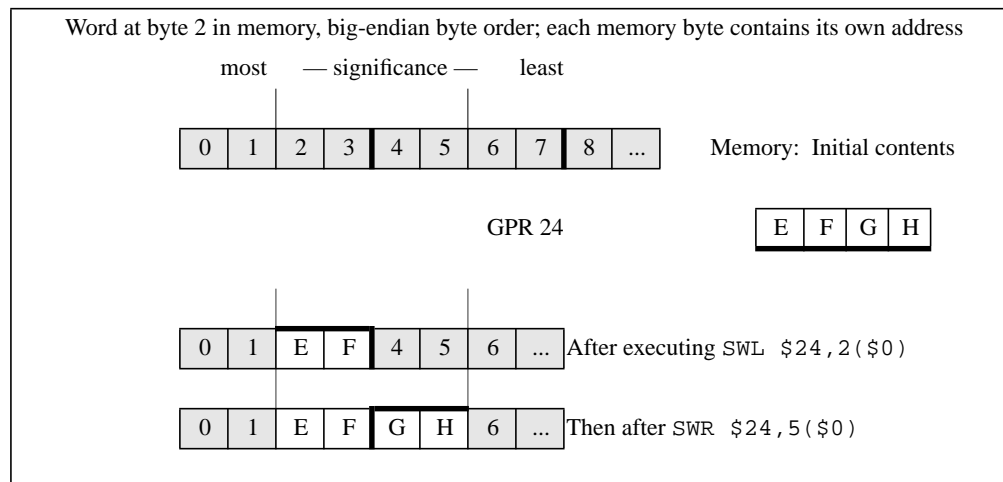

The bytes stored from the source register to memory depend on both the offset of the effective address within an aligned word—that is, the low 2 bits of the address (*vAddr1..0*)—and the current byte-ordering mode of the processor (big- or little-endian). The following figure shows the bytes stored for every combination of offset and byte ordering.

Figure 3-7 Bytes Stored by an SWL Instruction

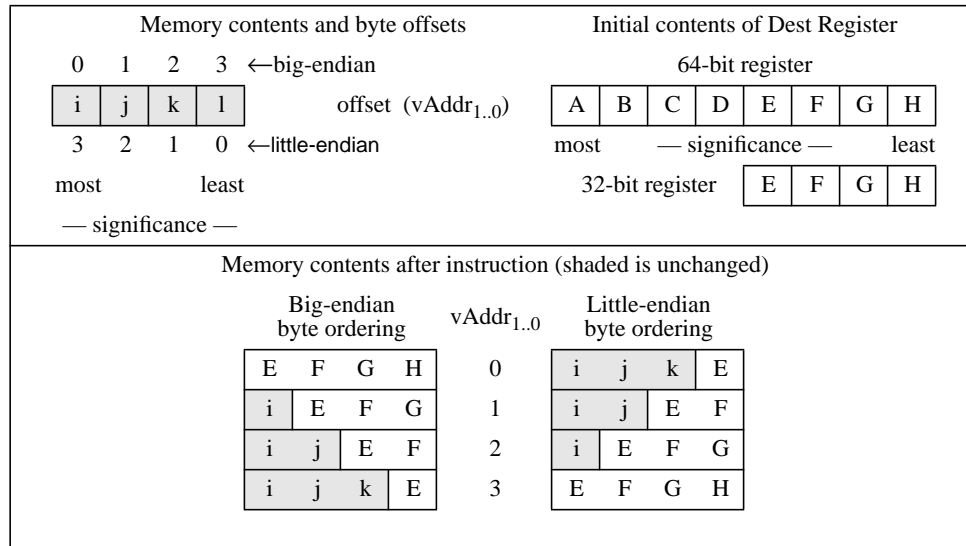
**Restrictions:**

None

Operation:

```

vAddr ← sign_extend(offset) + GPR[base]
(pAddr, CCA) ← AddressTranslation(vAddr, DATA, STORE)
pAddr ← pAddrPSIZE-1..2 || (pAddr1..0 xor ReverseEndian2)
If BigEndianMem = 0 then
  pAddr ← pAddrPSIZE-1..2 || 02
endif
byte ← vAddr1..0 xor BigEndianCPU2
dataword ← 024-8*byte || GPR[rt]31..24-8*byte
StoreMemory(CCA, byte, dataword, pAddr, vAddr, DATA)

```

Exceptions:

TLB Refill, TLB Invalid, TLB Modified, Bus Error, Address Error

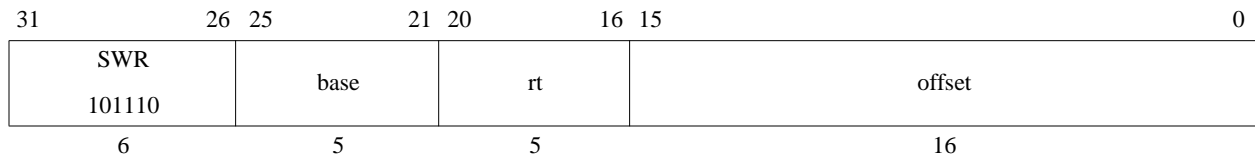

Format: SWR *rt*, *offset*(*base*)

MIPS32 (MIPS I)

Purpose:

To store the least-significant part of a word to an unaligned memory address

Description: $\text{memory}[\text{base}+\text{offset}] \leftarrow \text{rt}$

The 16-bit signed *offset* is added to the contents of GPR *base* to form an effective address (*EffAddr*). *EffAddr* is the address of the least-significant of 4 consecutive bytes forming a word (*W*) in memory starting at an arbitrary byte boundary.

A part of *W*, the least-significant 1 to 4 bytes, is in the aligned word containing *EffAddr*. The same number of the least-significant (right) bytes from the word in GPR *rt* are stored into these bytes of *W*.

The following figure illustrates this operation using big-endian byte ordering for 32-bit and 64-bit registers. The 4 consecutive bytes in 2..5 form an unaligned word starting at location 2. A part of *W*, 2 bytes, is contained in the aligned word containing the least-significant byte at 5. First, SWR stores the least-significant 2 bytes of the low word from the source register into these 2 bytes in memory. Next, the complementary SWL stores the remainder of the unaligned word.

Figure 3-8 Unaligned Word Store Using SWR and SWL

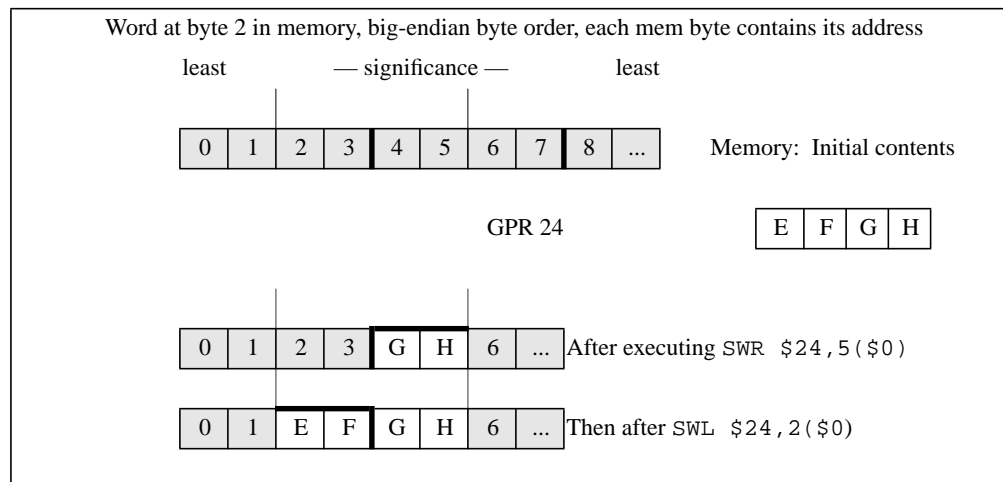

The bytes stored from the source register to memory depend on both the offset of the effective address within an aligned word—that is, the low 2 bits of the address ($vAddr_{1..0}$)—and the current byte-ordering mode of the processor (big- or little-endian). The following figure shows the bytes stored for every combination of offset and byte-ordering.

Figure 3-9 Bytes Stored by SWR Instruction

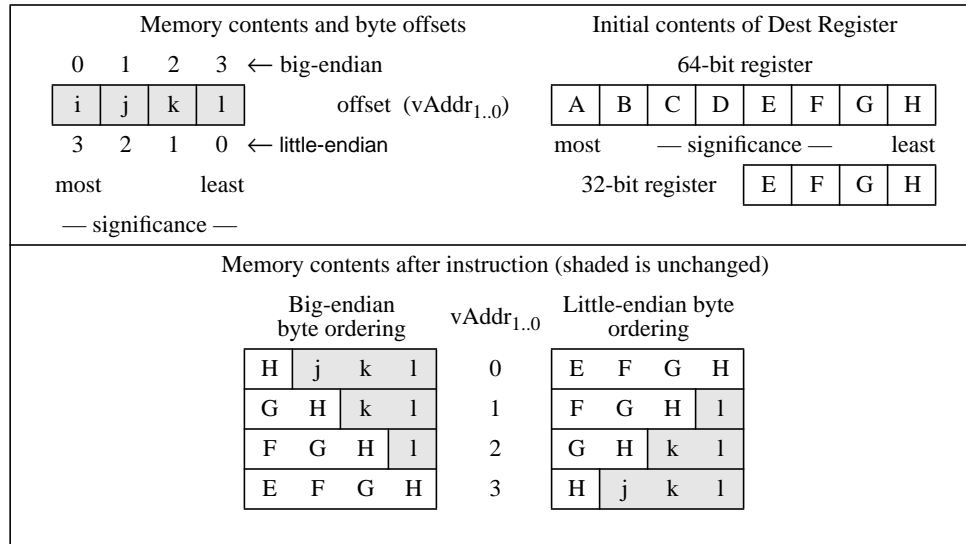

Restrictions:

None

Operation:

```

vAddr ← sign_extend(offset) + GPR[base]
(pAddr, CCA) ← AddressTranslation(vAddr, DATA, STORE)
pAddr ← pAddrPSIZE-1..2 || (pAddr1..0 xor ReverseEndian2)
If BigEndianMem = 0 then
    pAddr ← pAddrPSIZE-1..2 || 02
endif
byte ← vAddr1..0 xor BigEndianCPU2
dataword ← GPR[rt]31-8*byte || 08*byte
StoreMemory(CCA, WORD-byte, dataword, pAddr, vAddr, DATA)

```

Exceptions:

TLB Refill, TLB Invalid, TLB Modified, Bus Error, Address Error

31	26 25	21 20	16 15	11 10	6 5	0
SPECIAL	0			styp	SYNC	
000000	00 0000 0000 0000 0				001111	
6	15			5	6	

Format: SYNC (styp = 0 implied)

MIPS32 (MIPS II)

Purpose:

To order loads and stores.

Description:

Simple Description:

- SYNC affects only *uncached* and *cached coherent* loads and stores. The loads and stores that occur before the SYNC must be completed before the loads and stores after the SYNC are allowed to start.
- Loads are completed when the destination register is written. Stores are completed when the stored value is visible to every other processor in the system.
- SYNC is required, potentially in conjunction with SSNOP, to guarantee that memory reference results are visible across operating mode changes. For example, a SYNC is required on some implementations on entry to and exit from Debug Mode to guarantee that memory affects are handled correctly.

Detailed Description:

- When the *styp* field has a value of zero, every synchronizable load and store that occurs in the instruction stream before the SYNC instruction must be globally performed before any synchronizable load or store that occurs after the SYNC can be performed, with respect to any other processor or coherent I/O module.
- SYNC does not guarantee the order in which instruction fetches are performed. The *styp* values 1-31 are reserved; they produce the same result as the value zero.
-

Terms:

Synchronizable: A load or store instruction is *synchronizable* if the load or store occurs to a physical location in shared memory using a virtual location with a memory access type of either *uncached* or *cached coherent*. *Shared memory* is memory that can be accessed by more than one processor or by a coherent I/O system module.

Performed load: A load instruction is *performed* when the value returned by the load has been determined. The result of a load on processor A has been *determined* with respect to processor or coherent I/O module B when a subsequent store to the location by B cannot affect the value returned by the load. The store by B must use the same memory access type as the load.

Performed store: A store instruction is *performed* when the store is observable. A store on processor A is *observable* with respect to processor or coherent I/O module B when a subsequent load of the location by B returns the value written by the store. The load by B must use the same memory access type as the store.

Globally performed load: A load instruction is *globally performed* when it is performed with respect to all processors and coherent I/O modules capable of storing to the location.

Globally performed store: A store instruction is *globally performed* when it is globally observable. It is *globally observable* when it is observable by all processors and I/O modules capable of loading from the location.

Coherent I/O module: A *coherent I/O module* is an Input/Output system component that performs coherent Direct Memory Access (DMA). It reads and writes memory independently as though it were a processor doing loads and stores to locations with a memory access type of *cached coherent*.

Restrictions:

The effect of SYNC on the global order of loads and stores for memory access types other than *uncached* and *cached coherent* is **UNPREDICTABLE**.

Operation:

`SyncOperation(stype)`

Exceptions:

None

Programming Notes:

A processor executing load and store instructions observes the order in which loads and stores using the same memory access type occur in the instruction stream; this is known as *program order*.

A *parallel program* has multiple instruction streams that can execute simultaneously on different processors. In multiprocessor (MP) systems, the order in which the effects of loads and stores are observed by other processors—the *global order* of the loads and store—determines the actions necessary to reliably share data in parallel programs.

When all processors observe the effects of loads and stores in program order, the system is *strongly ordered*. On such systems, parallel programs can reliably share data without explicit actions in the programs. For such a system, SYNC has the same effect as a NOP. Executing SYNC on such a system is not necessary, but neither is it an error.

If a multiprocessor system is not strongly ordered, the effects of load and store instructions executed by one processor may be observed out of program order by other processors. On such systems, parallel programs must take explicit actions to reliably share data. At critical points in the program, the effects of loads and stores from an instruction stream must occur in the same order for all processors. SYNC separates the loads and stores executed on the processor into two groups, and the effect of all loads and stores in one group is seen by all processors before the effect of any load or store in the subsequent group. In effect, SYNC causes the system to be strongly ordered for the executing processor at the instant that the SYNC is executed.

Many MIPS-based multiprocessor systems are strongly ordered or have a mode in which they operate as strongly ordered for at least one memory access type. The MIPS architecture also permits implementation of MP systems that are not strongly ordered; SYNC enables the reliable use of shared memory on such systems. A parallel program that does not use SYNC generally does not operate on a system that is not strongly ordered. However, a program that does use SYNC works on both types of systems. (System-specific documentation describes the actions needed to reliably share data in parallel programs for that system.)

The behavior of a load or store using one memory access type is undefined if a load or store was previously made to the same physical location using a different memory access type. The presence of a SYNC between the references does not alter this behavior.

SYNC affects the order in which the effects of load and store instructions appear to all processors; it does not generally affect the physical memory-system ordering or synchronization issues that arise in system programming. The effect of SYNC on implementation-specific aspects of the cached memory system, such as writeback buffers, is not defined. The effect of SYNC on reads or writes to memory caused by privileged implementation-specific instructions, such as CACHE, also is not defined.

```
# Processor A (writer)
# Conditions at entry:
# The value 0 has been stored in FLAG and that value is observable by B
SW    R1, DATA      # change shared DATA value
LI    R2, 1
SYNC                      # Perform DATA store before performing FLAG store
SW    R2, FLAG       # say that the shared DATA value is valid

# Processor B (reader)
LI    R2, 1
1: LW  R1, FLAG      # Get FLAG
   BNE R2, R1, 1B   # if it says that DATA is not valid, poll again
   NOP
   SYNC            # FLAG value checked before doing DATA read
   LW  R1, DATA   # Read (valid) shared DATA value
```

Prefetch operations have no effect detectable by User-mode programs, so ordering the effects of prefetch operations is not meaningful.

The code fragments above shows how SYNC can be used to coordinate the use of shared data between separate writer and reader instruction streams in a multiprocessor environment. The FLAG location is used by the instruction streams to determine whether the shared data item DATA is valid. The SYNC executed by processor A forces the store of DATA to be performed globally before the store to FLAG is performed. The SYNC executed by processor B ensures that DATA is not read until after the FLAG value indicates that the shared data is valid.

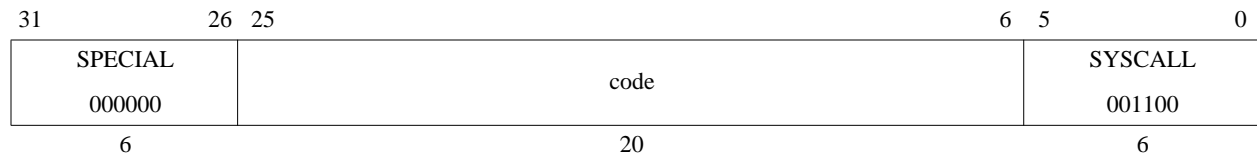

Format: SYSCALL

MIPS32 (MIPS I)

Purpose:

To cause a System Call exception

Description:

A system call exception occurs, immediately and unconditionally transferring control to the exception handler.

The *code* field is available for use as software parameters, but is retrieved by the exception handler only by loading the contents of the memory word containing the instruction.

Restrictions:

None

Operation:

```
SignalException(SystemCall)
```

Exceptions:

System Call

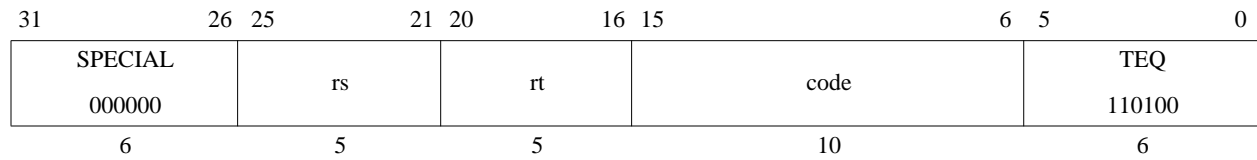
Trap if Equal**TEQ****Format:** TEQ *rs*, *rt***MIPS32 (MIPS II)****Purpose:**

To compare GPRs and do a conditional trap

Description: if *rs* = *rt* then TrapCompare the contents of GPR *rs* and GPR *rt* as signed integers; if GPR *rs* is equal to GPR *rt*, then take a Trap exception.The contents of the *code* field are ignored by hardware and may be used to encode information for system software. To retrieve the information, system software must load the instruction word from memory.**Restrictions:**

None

Operation:

```

if GPR[rs] = GPR[rt] then
    SignalException(Trap)
endif

```

Exceptions:

Trap

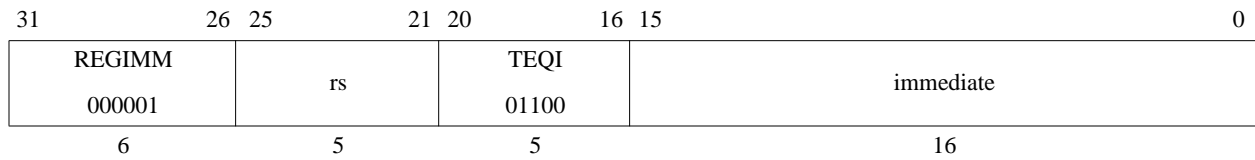
Trap if Equal Immediate**TEQI****Format:** `TEQI rs, immediate`**MIPS32 (MIPS II)****Purpose:**

To compare a GPR to a constant and do a conditional trap

Description: `if rs = immediate then Trap`Compare the contents of GPR *rs* and the 16-bit signed *immediate* as signed integers; if GPR *rs* is equal to *immediate*, then take a Trap exception.**Restrictions:**

None

Operation:

```

if GPR[rs] = sign_extend(immediate) then
    SignalException(Trap)
endif

```

Exceptions:

Trap

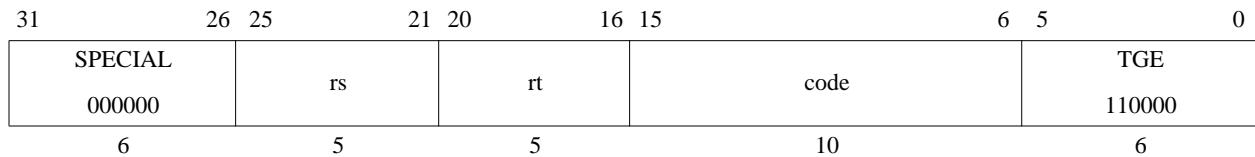
Trap if Greater or Equal**TGE****Format:** TGE *rs*, *rt***MIPS32 (MIPS II)****Purpose:**

To compare GPRs and do a conditional trap

Description: if $rs \geq rt$ then TrapCompare the contents of GPR *rs* and GPR *rt* as signed integers; if GPR *rs* is greater than or equal to GPR *rt*, then take a Trap exception.The contents of the *code* field are ignored by hardware and may be used to encode information for system software. To retrieve the information, system software must load the instruction word from memory.**Restrictions:**

None

Operation:

```
if GPR[rs] ≥ GPR[rt] then
    SignalException(Trap)
endif
```

Exceptions:

Trap

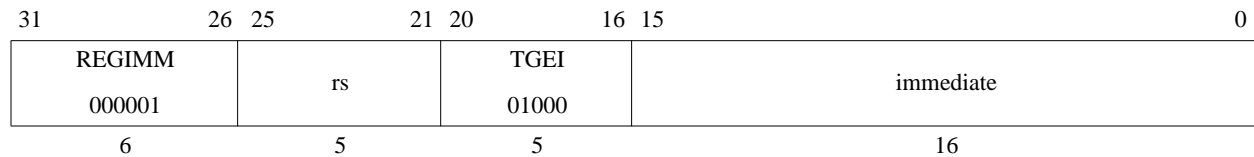
Trap if Greater or Equal Immediate**TGEI****Format:** TGEI rs, immediate**MIPS32 (MIPS II)****Purpose:**

To compare a GPR to a constant and do a conditional trap

Description: if $rs \geq immediate$ then TrapCompare the contents of GPR *rs* and the 16-bit signed *immediate* as signed integers; if GPR *rs* is greater than or equal to *immediate*, then take a Trap exception.**Restrictions:**

None

Operation:

```

if GPR[rs] ≥ sign_extend(immediate) then
    SignalException(Trap)
endif

```

Exceptions:

Trap

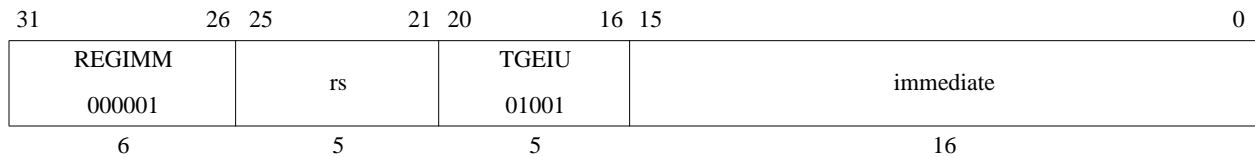
Trap if Greater or Equal Immediate Unsigned**TGEIU****Format:** TGEIU rs, immediate**MIPS32 (MIPS II)****Purpose:**

To compare a GPR to a constant and do a conditional trap

Description: if $rs \geq immediate$ then TrapCompare the contents of GPR *rs* and the 16-bit sign-extended *immediate* as unsigned integers; if GPR *rs* is greater than or equal to *immediate*, then take a Trap exception.Because the 16-bit *immediate* is sign-extended before comparison, the instruction can represent the smallest or largest unsigned numbers. The representable values are at the minimum [0, 32767] or maximum [max_unsigned-32767, max_unsigned] end of the unsigned range.**Restrictions:**

None

Operation:

```

if (0 || GPR[rs]) ≥ (0 || sign_extend(immediate)) then
    SignalException(Trap)
endif

```

Exceptions:

Trap

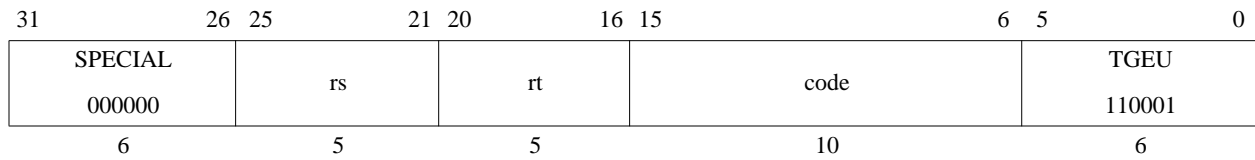
Trap if Greater or Equal Unsigned**TGEU****Format:** TGEU *rs*, *rt***MIPS32 (MIPS II)****Purpose:**

To compare GPRs and do a conditional trap

Description: if $rs \geq rt$ then TrapCompare the contents of GPR *rs* and GPR *rt* as unsigned integers; if GPR *rs* is greater than or equal to GPR *rt*, then take a Trap exception.The contents of the *code* field are ignored by hardware and may be used to encode information for system software. To retrieve the information, system software must load the instruction word from memory.**Restrictions:**

None

Operation:

```

if (0 || GPR[rs]) ≥ (0 || GPR[rt]) then
    SignalException(Trap)
endif

```

Exceptions:

Trap

Probe TLB for Matching Entry

TLBP

31	26	25	24	6	5	0
COP0	CO	0			TLBP	
010000	1	000 0000 0000 0000 0000			001000	
6	1	19			6	

Format: TLBP

MIPS32

Purpose:

To find a matching entry in the TLB.

Description:

The *Index* register is loaded with the address of the TLB entry whose contents match the contents of the *EntryHi* register. If no TLB entry matches, the high-order bit of the *Index* register is set.

Restrictions:

Operation:

```

Index ← 1 || UNPREDICTABLE31
for i in 0...TLBEntries-1
  if ((TLB[i]VPN2 and not (TLB[i]Mask)) =
      (EntryHiVPN2 and not (TLB[i]Mask))) and
      ((TLB[i]G = 1) or (TLB[i]ASID = EntryHiASID))then
    Index ← i
  endif
endfor

```

Exceptions:

Coprocessor Unusable

Read Indexed TLB Entry

TLBR

31	26	25	24	6	5	0
COP0	CO	0			TLBR	
010000	1	000 0000 0000 0000 0000			000001	
6	1	19			6	

Format: TLBR

MIPS32

Purpose:

To read an entry from the TLB.

Description:

The *EntryHi*, *EntryLo0*, *EntryLo1*, and *PageMask* registers are loaded with the contents of the TLB entry pointed to by the Index register. Note that the value written to the *EntryHi*, *EntryLo0*, and *EntryLo1* registers may be different from that originally written to the TLB via these registers in that:

- The value returned in the VPN2 field of the *EntryHi* register may have those bits set to zero corresponding to the one bits in the Mask field of the TLB entry (the least significant bit of VPN2 corresponds to the least significant bit of the Mask field). It is implementation dependent whether these bits are preserved or zeroed after a TLB entry is written and then read.
- The value returned in the PFN field of the *EntryLo0* and *EntryLo1* registers may have those bits set to zero corresponding to the one bits in the Mask field of the TLB entry (the least significant bit of PFN corresponds to the least significant bit of the Mask field). It is implementation dependent whether these bits are preserved or zeroed after a TLB entry is written and then read.
- The value returned in the G bit in both the *EntryLo0* and *EntryLo1* registers comes from the single G bit in the TLB entry. Recall that this bit was set from the logical AND of the two G bits in *EntryLo0* and *EntryLo1* when the TLB was written.

Restrictions:

The operation is **UNDEFINED** if the contents of the Index register are greater than or equal to the number of TLB entries in the processor.

Operation:

```

i ← Index
if i > (TLBEntries - 1) then
    UNDEFINED
endif
PageMaskMask ← TLB[i]Mask
EntryHi ←
    (TLB[i]VPN2 and not TLB[i]Mask) || # Masking implementation dependent
    05 || TLB[i]ASID
EntryLo1 ← 02 ||
    (TLB[i]PFN1 and not TLB[i]Mask) || # Masking mplementation dependent
    TLB[i]C1 || TLB[i]D1 || TLB[i]V1 || TLB[i]G
EntryLo0 ← 02 ||
    (TLB[i]PFN0 and not TLB[i]Mask) || # Masking mplementation dependent
    TLB[i]C0 || TLB[i]D0 || TLB[i]V0 || TLB[i]G

```

Exceptions:

Coprocessor Unusable

Write Indexed TLB Entry

TLBWI

31	26	25	24	6	5	0
COP0	CO	0			TLBWI	
010000	1	000 0000 0000 0000 0000			000010	
6	1	19			6	

Format: TLBWI

MIPS32

Purpose:

To write a TLB entry indexed by the *Index* register.

Description:

The TLB entry pointed to by the *Index* register is written from the contents of the *EntryHi*, *EntryLo0*, *EntryLo1*, and *PageMask* registers. The information written to the TLB entry may be different from that in the *EntryHi*, *EntryLo0*, and *EntryLo1* registers, in that:

- The value written to the VPN2 field of the TLB entry may have those bits set to zero corresponding to the one bits in the Mask field of the *PageMask* register (the least significant bit of VPN2 corresponds to the least significant bit of the Mask field). It is implementation dependent whether these bits are preserved or zeroed during a TLB write.
- The value written to the PFN0 and PFN1 fields of the TLB entry may have those bits set to zero corresponding to the one bits in the Mask field of *PageMask* register (the least significant bit of PFN corresponds to the least significant bit of the Mask field). It is implementation dependent whether these bits are preserved or zeroed during a TLB write.
- The single G bit in the TLB entry is set from the logical AND of the G bits in the *EntryLo0* and *EntryLo1* registers.

Restrictions:

The operation is **UNDEFINED** if the contents of the *Index* register are greater than or equal to the number of TLB entries in the processor.

Operation:

```
i ← Index
TLB[i]Mask ← PageMaskMask
TLB[i]VPN2 ← EntryHiVPN2 and not PageMaskMask # Implementation dependent
TLB[i]ASID ← EntryHiASID
TLB[i]G ← EntryLo1G and EntryLo0G
TLB[i]PFN1 ← EntryLo1PFN and not PageMaskMask # Implementation dependent
TLB[i]C1 ← EntryLo1C
TLB[i]D1 ← EntryLo1D
TLB[i]V1 ← EntryLo1V
TLB[i]PFN0 ← EntryLo0PFN and not PageMaskMask # Implementation dependent
TLB[i]C0 ← EntryLo0C
TLB[i]D0 ← EntryLo0D
TLB[i]V0 ← EntryLo0V
```

Exceptions:

Coprocessor Unusable

Write Random TLB Entry

TLBWR

31	26	25	24	6	5	0
COP0	CO	0			TLBWR	
010000	1	000 0000 0000 0000 0000			000110	
6	1	19			6	

Format: TLBWR

MIPS32

Purpose:

To write a TLB entry indexed by the *Random* register.

Description:

The TLB entry pointed to by the *Random* register is written from the contents of the *EntryHi*, *EntryLo0*, *EntryLo1*, and *PageMask* registers. The information written to the TLB entry may be different from that in the *EntryHi*, *EntryLo0*, and *EntryLo1* registers, in that:

- The value written to the VPN2 field of the TLB entry may have those bits set to zero corresponding to the one bits in the Mask field of the *PageMask* register (the least significant bit of VPN2 corresponds to the least significant bit of the Mask field). It is implementation dependent whether these bits are preserved or zeroed during a TLB write.
- The value written to the PFN0 and PFN1 fields of the TLB entry may have those bits set to zero corresponding to the one bits in the Mask field of *PageMask* register (the least significant bit of PFN corresponds to the least significant bit of the Mask field). It is implementation dependent whether these bits are preserved or zeroed during a TLB write.
- The value returned in the G bit in both the *EntryLo0* and *EntryLo1* registers comes from the single G bit in the TLB entry. Recall that this bit was set from the logical AND of the two G bits in *EntryLo0* and *EntryLo1* when the TLB was written.

Restrictions:

The operation is **UNDEFINED** if the contents of the Index register are greater than or equal to the number of TLB entries in the processor.

Operation:

```
i ← Random
TLB[i]Mask ← PageMaskMask
TLB[i]VPN2 ← EntryHiVPN2 and not PageMaskMask # Implementation dependent
TLB[i]ASID ← EntryHiASID
TLB[i]G ← EntryLo1G and EntryLo0G
TLB[i]PFN1 ← EntryLo1PFN and not PageMaskMask # Implementation dependent
TLB[i]C1 ← EntryLo1C
TLB[i]D1 ← EntryLo1D
TLB[i]V1 ← EntryLo1V
TLB[i]PFN0 ← EntryLo0PFN and not PageMaskMask # Implementation dependent
TLB[i]C0 ← EntryLo0C
TLB[i]D0 ← EntryLo0D
TLB[i]V0 ← EntryLo0V
```

Exceptions:

Coprocessor Unusable

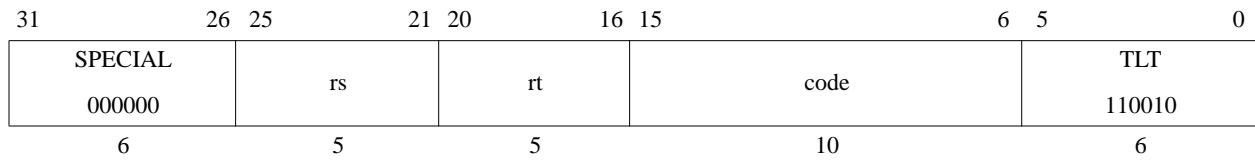
Trap if Less Than**TLT****Format:** TLT *rs*, *rt***MIPS32 (MIPS II)****Purpose:**

To compare GPRs and do a conditional trap

Description: if *rs* < *rt* then TrapCompare the contents of GPR *rs* and GPR *rt* as signed integers; if GPR *rs* is less than GPR *rt*, then take a Trap exception.The contents of the *code* field are ignored by hardware and may be used to encode information for system software. To retrieve the information, system software must load the instruction word from memory.**Restrictions:**

None

Operation:

```
if GPR[rs] < GPR[rt] then
    SignalException(Trap)
endif
```

Exceptions:

Trap

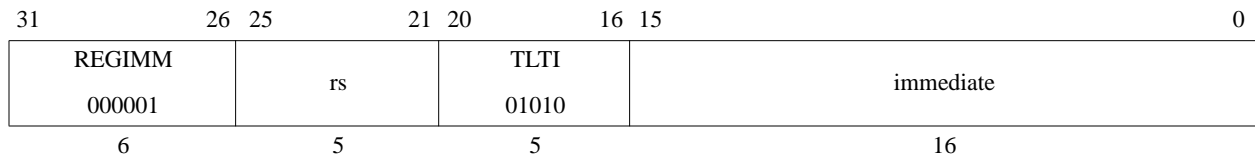
Trap if Less Than Immediate**TLTI****Format:** TLTI rs, immediate**MIPS32 (MIPS II)****Purpose:**

To compare a GPR to a constant and do a conditional trap

Description: if $rs < immediate$ then TrapCompare the contents of GPR *rs* and the 16-bit signed *immediate* as signed integers; if GPR *rs* is less than *immediate*, then take a Trap exception.**Restrictions:**

None

Operation:

```

if GPR[rs] < sign_extend(immediate) then
    SignalException(Trap)
endif

```

Exceptions:

Trap

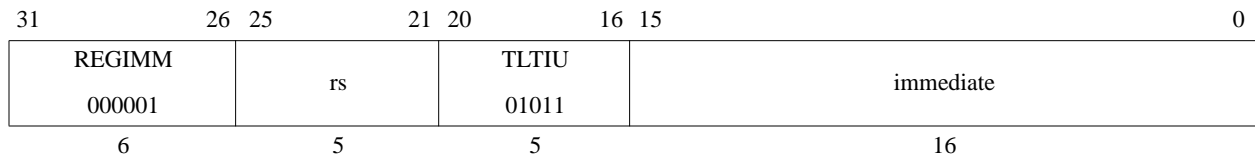
Trap if Less Than Immediate Unsigned**TLTIU****Format:** TLTIU rs, immediate**MIPS32 (MIPS II)****Purpose:**

To compare a GPR to a constant and do a conditional trap

Description: if *rs* < *immediate* then TrapCompare the contents of GPR *rs* and the 16-bit sign-extended *immediate* as unsigned integers; if GPR *rs* is less than *immediate*, then take a Trap exception.Because the 16-bit *immediate* is sign-extended before comparison, the instruction can represent the smallest or largest unsigned numbers. The representable values are at the minimum [0, 32767] or maximum [max_unsigned-32767, max_unsigned] end of the unsigned range.**Restrictions:**

None

Operation:

```

if (0 || GPR[rs]) < (0 || sign_extend(immediate)) then
    SignalException(Trap)
endif

```

Exceptions:

Trap

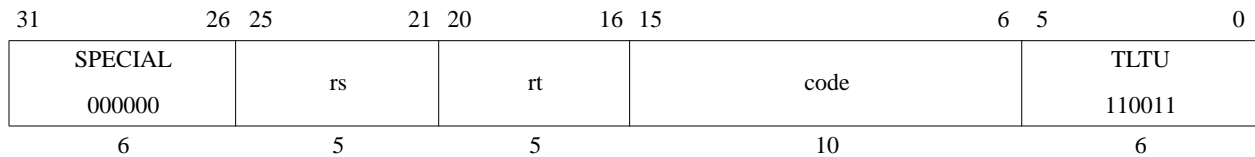
Trap if Less Than Unsigned**TLTU****Format:** TLTU *rs*, *rt***MIPS32 (MIPS II)****Purpose:**

To compare GPRs and do a conditional trap

Description: `if rs < rt then Trap`Compare the contents of GPR *rs* and GPR *rt* as unsigned integers; if GPR *rs* is less than GPR *rt*, then take a Trap exception.The contents of the *code* field are ignored by hardware and may be used to encode information for system software. To retrieve the information, system software must load the instruction word from memory.**Restrictions:**

None

Operation:

```

if (0 || GPR[rs]) < (0 || GPR[rt]) then
    SignalException(Trap)
endif

```

Exceptions:

Trap

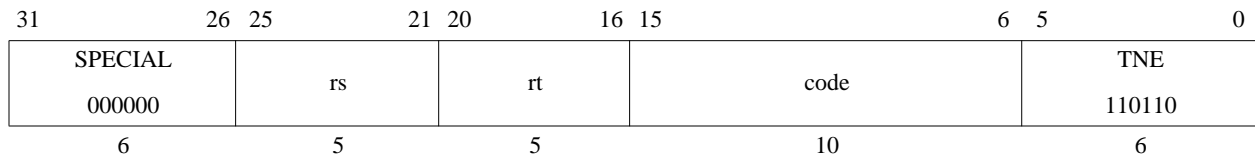
Trap if Not Equal**TNE****Format:** TNE *rs*, *rt***MIPS32 (MIPS II)****Purpose:**

To compare GPRs and do a conditional trap

Description: if *rs* \neq *rt* then TrapCompare the contents of GPR *rs* and GPR *rt* as signed integers; if GPR *rs* is not equal to GPR *rt*, then take a Trap exception.The contents of the *code* field are ignored by hardware and may be used to encode information for system software. To retrieve the information, system software must load the instruction word from memory.**Restrictions:**

None

Operation:

```
if GPR[rs]  $\neq$  GPR[rt] then
    SignalException(Trap)
endif
```

Exceptions:

Trap

Trap if Not Equal

TNEI

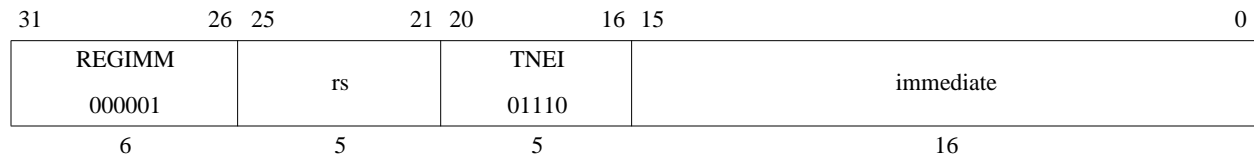
**Format:** TNEI rs, immediate**MIPS32 (MIPS II)****Purpose:**

To compare a GPR to a constant and do a conditional trap

Description: if $rs \neq \text{immediate}$ then TrapCompare the contents of GPR *rs* and the 16-bit signed *immediate* as signed integers; if GPR *rs* is not equal to *immediate*, then take a Trap exception.**Restrictions:**

None

Operation:

```

if GPR[rs]  $\neq$  sign_extend(immediate) then
    SignalException(Trap)
endif

```

Exceptions:

Trap

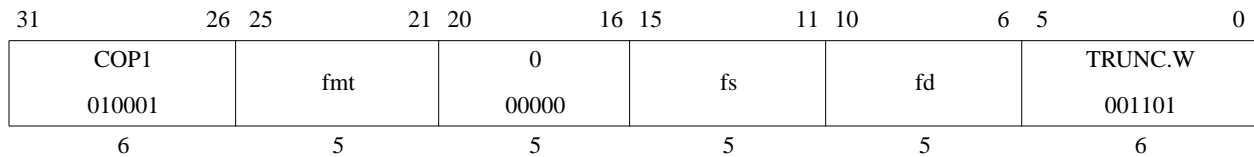

Format: TRUNC.W.S *fd*, *fs*
 TRUNC.W.D *fd*, *fs*

MIPS32 (MIPS II)
MIPS32 (MIPS II)

Purpose:

To convert an FP value to 32-bit fixed point, rounding toward zero

Description: $fd \leftarrow \text{convert_and_round}(fs)$

The value in FPR *fs*, in format *fmt*, is converted to a value in 32-bit word fixed point format using rounding toward zero (rounding mode 1). The result is placed in FPR *fd*.

When the source value is Infinity, NaN, or rounds to an integer outside the range -2^{31} to $2^{31}-1$, the result cannot be represented correctly and an IEEE Invalid Operation condition exists. In this case the Invalid Operation flag is set in the *FCSR*. If the Invalid Operation *Enable* bit is set in the *FCSR*, no result is written to *fd* and an Invalid Operation exception is taken immediately. Otherwise, the default result, $2^{31}-1$, is written to *fd*.

Restrictions:

The fields *fs* and *fd* must specify valid FPRs; *fs* for type *fmt* and *fd* for word fixed point; if they are not valid, the result is **UNPREDICTABLE**.

The operand must be a value in format *fmt*; if it is not, the result is **UNPREDICTABLE** and the value of the operand FPR becomes **UNPREDICTABLE**.

Operation:

`StoreFPR(fd, W, ConvertFmt(ValueFPR(fs, fmt), fmt, W))`

Exceptions:

Coprocessor Unusable, Reserved Instruction

Floating Point Exceptions:

Inexact, Invalid Operation, Overflow, Unimplemented Operation

Enter Standby Mode**WAIT**

31	26 25 24		6 5	0
COP0 010000	CO 1	Implementation-Dependent Code	WAIT 100000	
6	1	19	6	

Format: WAIT**MIPS32****Purpose:**

Wait for Event

Description:

The WAIT instruction performs an implementation-dependent operation, usually involving a lower power mode. Software may use bits 24:6 of the instruction to communicate additional information to the processor, and the processor may use this information as control for the lower power mode. A value of zero for bits 24:6 is the default and must be valid in all implementations.

The WAIT instruction is typically implemented by stalling the pipeline at the completion of the instruction and entering a lower power mode. The pipeline is restarted when an external event, such as an interrupt or external request occurs, and execution continues with the instruction following the WAIT instruction. It is implementation-dependent whether the pipeline restarts when a non-enabled interrupt is requested. In this case, software must poll for the cause of the restart. If the pipeline restarts as the result of an enabled interrupt, that interrupt is taken between the WAIT instruction and the following instruction (EPC for the interrupt points at the instruction following the WAIT instruction).

The assertion of any reset or NMI must restart the pipeline and the corresponding exception must be taken.

Restrictions:

The operation of the processor is **UNDEFINED** if a WAIT instruction is placed in the delay slot of a branch or a jump.

Operation:

Enter implementation dependent lower power mode

Exceptions:

Coprocessor Unusable Exception

31	26 25	21 20	16 15	11 10	6 5	0
SPECIAL 000000	rs	rt	rd	0 00000	XOR 100110	
6	5	5	5	5	6	

Format: XOR rd, rs, rt

MIPS32 (MIPS I)

Purpose:

To do a bitwise logical Exclusive OR

Description: $rd \leftarrow rs \text{ XOR } rt$

Combine the contents of GPR *rs* and GPR *rt* in a bitwise logical Exclusive OR operation and place the result into GPR *rd*.

Restrictions:

None

Operation:

$GPR[rd] \leftarrow GPR[rs] \text{ xor } GPR[rt]$

Exceptions:

None

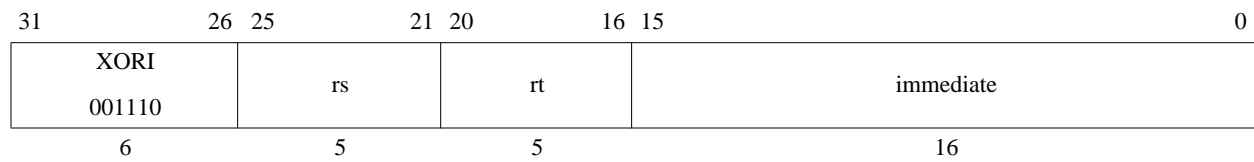

Format: XORI *rt*, *rs*, *immediate*

MIPS32 (MIPS I)

Purpose:

To do a bitwise logical Exclusive OR with a constant

Description: $rt \leftarrow rs \text{ XOR } immediate$

Combine the contents of GPR *rs* and the 16-bit zero-extended *immediate* in a bitwise logical Exclusive OR operation and place the result into GPR *rt*.

Restrictions:

None

Operation:

$GPR[rt] \leftarrow GPR[rs] \text{ xor } zero_extend(immediate)$

Exceptions:

None

Revision History

Revision	Date	Description
0.90	November 1, 2000	Internal review copy of reorganized and updated architecture documentation.
0.91	November 15, 2000	External review copy of reorganized and updated architecture documentation.
		Changes in this revision:
0.92	December 15, 2000	<ul style="list-style-type: none">• Correct sign in description of MSUBU.• Update JR and JALR instructions to reflect the changes required by MIPS16.
0.95	March 12, 2001	Update for second external review release.